

S P A C E

S P A C E

**S P A C E**

S P A C E

S P A C E

LET  
THE OUTER  
SPACE  
IN.

-EXALCO-







## SPACE

Μία νέα πρωτοποριακή σειρά συρόμενων συστημάτων, που διακρίνονται για την καινοτομία τους και τον minimal σχεδιασμό, με ελάχιστα ή και καθόλου εμφανή προφίλ αλουμινίου, για απεριόριστη θέα, υπερσύγχρονη αισθητική και κορυφαία ποιότητα ζωής.

Με χαμηλούς δείκτες θερμοπερατότητας και άριστη ηχομόνωση, καθιστούν δυνατή την κατασκευή όλων των τυπολογιών συρόμενων, καθώς και απεριόριστων κινούμενων φύλλων. Ιδανικά για υάλωση μεγάλης επιφάνειας, κινούν βάρος φύλλου (χειροκίνητα έως 400Kg και με μοτέρ άνω των 400Kg) και διαθέτουν ευέλικτο ειδικό σύστημα απορροής υδάτων με νεροχύτη, είτε εμφανή είτε κρυφό.

Αποτελούν τα μοναδικά μίνιμαλ συρόμενα συστήματα που δέχονται εύκολη και γρήγορη αντικατάσταση του υαλοπίνακα σε περίπτωση θραύσης ή φθοράς των εξαρτημάτων, χωρίς να αφαιρεθεί το πλαίσιο!

A brand-new innovative range of minimal sliding frames with extra slim or invisible aluminum profiles, designed and developed to bring superior aesthetics, ultra-wide uninterrupted views, and the utmost living experience into every contemporary space.

Having low heat transfer indices and excellent sound insulation, the systems allow the manufacturing of all sliding typologies, as well as unlimited moving sheets. Ideal for large-surface glazing, it supports panels with a sheet weight (manual up to 400 Kg and with motor for 400+Kg).

Also, it includes a flexible special drainage system with a sink, either visible or hidden. Replacing the glass panels, as well as the accessories is easy and immediate since you don't have to remove the frame!

## ΒΑΣΙΚΑ ΧΑΡΑΚΤΗΡΙΣΤΙΚΑ ΣΥΣΤΗΜΑΤΟΣ

- Minimal σχεδιασμός με ελάχιστα ή και καθόλου ορατά προφίλ
- Ευελιξία στην κατασκευή:
  - ⊕ εφαρμογή όλων των τυπολογιών συρόμενων
  - ⊕ απεριόριστα κινητά φύλλα
  - ⊕ τρεις επιλογές κατασκευής: invisible, inside out, replace
- Χαμηλοί δείκτες θερμομόνωσης
- Άριστη ηχομόνωση με χρήση υαλοπινάκων έως και 44mm
- Εύκολη και γρήγορη αντικατάσταση υαλοπινάκων σε περίπτωση θραύσης ή φθοράς των εξαρτημάτων χωρίς να αφαιρεθεί το πλαίσιο
- Δυνατότητα υάλωσης μεγάλης επιφάνειας
- Άψογη λειτουργικότητα λόγω δυνατότητας κύλισης φύλλου βάρους (χειροκίνητα έως 400Kg και με μοτέρ για 400+Kg)
- Ευέλικτο σύστημα απορροής υδάτων με εμφανή ή κρυφό νεροχύτη
- Δυνατότητα τοποθέτησης συρόμενης ή κρυφής σίτας

## BASIC SYSTEM CHARACTERISTICS

- Minimal design with minimally visible or invisible profiles
- Flexibility in construction:
  - ⊕ application of all sliding typologies
  - ⊕ unlimited movable sashes
  - ⊕ three choices of construction: invisible, inside out, replace
- Low thermal insulation values
- Excellent sound insulation using glazing up to 44mm
- Easy and rapid replacement of glazing in case of break or wear of accessories without removing the frame.
- Possibility of using glazing in a large surface area
- Flawless functionality due to rolling sashes (manual up to 400Kg, with motor for 400+Kg)
- Flexible water drainage system with an obvious or hidden sink
- Possibility of placement of a sliding or hidden screen

## ΤΡΕΙΣ ΕΠΙΛΟΓΕΣ ΚΑΤΑΣΚΕΥΗΣ THREE CONSTRUCTION OPTIONS

### space inside out

Τα κάθετα προφίλ αποτελούν τα μόνα ορατά προφίλ αλουμινίου.

The vertical profiles are the only visible aluminium profiles of the system.

### space invisible

Δυνατότητα ανεμπόδιστης συνέχειας εσωτερικού και εξωτερικού δαπέδου με πλήρη κάλυψη του κάτω οδηγού (ορατού σαν μια γραμμή).

The buried guide, only visible as two lines, provides the possibility of floor extension from the inside out.

### space replace

Το ύψος της κάσας στο κάτω μέρος στα 33mm, το καθιστά ιδανική λύση για αντικατάσταση παλιών κουφωμάτων χωρίς επιπλέον εργασίες και σκαψίματα ενώ το ορατό προφίλ του φύλλου αλουμινίου είναι 22mm.

The height of frame of 33mm makes it an ideal solution for the replacement of old frames without extra works and digging. The visible aluminium profile of the sash is 22mm.

ΠΕΡΙΕΧΟΜΕΝΑ/CONTENTS	ΣΕΛ/PG
- ΕΙΣΑΓΩΓΗ / INTRO	4
- ΤΥΠΟΛΟΓΙΑ / TYPOLOGY	7
- SPACE INSIDE OUT	9
- SPACE INVISIBLE	37
- SPACE REPLACE	59

## ΤΕΧΝΙΚΑ ΧΑΡΑΚΤΗΡΙΣΤΙΚΑ

Πάχος υάλωσης φύλλου τζαμιού  
Χειροκίνητο βάρος φύλλου  
Ηλεκτροκίνητο βάρος φύλλου

**28-44mm**  
max **400Kg**  
**400Kg+**

Συντελεστής θερμοπερατότητας  
για διάσταση κουφώματος διαστάσεων 3,60x2,80m και υαλοπίνακα με  $U_g = 1,0W/m^2K$

**$U_w = 1,38W/m^2 K$**

Υδατοστεγανότητα σύμφωνα με  
Αεροδιαπερατότητα σύμφωνα με  
Αντοχή σε ανεμοπίεση σύμφωνα με  
Ηχομείωση σύμφωνα με

**EN 12208:1999-11 / Class: E750**  
**EN 12207:2016-12 / Class: 4**  
**EN 12210:2016-03 / Class: C4/B4**  
**EN ISO 10140-2: 2021-05, EN ISO 717-1: 2020-12 /  $R_w=43dB$**

## TECHNICAL INFO

Glazing thickness  
Manual sheet weight  
Electric motor sheet weight

**28-44mm**  
max **400Kg**  
**400Kg+**

Thermal transmittance coefficient  
for frame dimensions of 3.60x2.80m and glazing with  $U_g = 1,0W/m^2K$

**$U_w = 1,38W/m^2 K$**

Waterproofing in accordance with  
Air permeability in accordance with  
Resistance to wind load in accordance with  
Sound reduction in accordance with

**EN 12208:1999-11 / Class: E750**  
**EN 12207:2016-12 / Class: 4**  
**EN 12210:2016-03 / Class: C4/B4**  
**EN ISO 10140-2: 2021-05, EN ISO 717-1: 2020-12 /  $R_w=43dB$**

## ΤΥΠΟΛΟΓΙΕΣ / TYPOLOGIES

INSIDE OUT | INVISIBLE | REPLACE

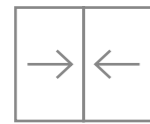

INSIDE OUT 10-12 | INVISIBLE 38-40 | REPLACE 60-61

ΠΑΡΑΘΥΡΟ ΔΙΦΥΛΛΟ ΕΠΑΛΛΗΛΟ  
DOUBLE-SASH WINDOW ON DOUBLE RAIL

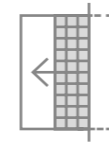

INSIDE OUT 25-27 | INVISIBLE 49-50 | REPLACE 71

ΠΑΡΑΘΥΡΟ ΜΟΝΟΦΥΛΛΟ ΧΩΝΕΥΤΟ ΜΕ ΣΙΤΑ  
SINGLE-SASH RECESSED WINDOW WITH MOSQUITO NET

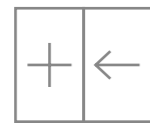

INSIDE OUT 13-15 | INVISIBLE 41 | REPLACE 62-63

ΠΑΡΑΘΥΡΟ ΔΙΦΥΛΛΟ ΕΠΑΛΛΗΛΟ ΜΕ ΕΝΑ ΣΤΑΘΕΡΟ ΦΥΛΛΟ  
DOUBLE-SASH WINDOW WITH ONE FIXED SASH

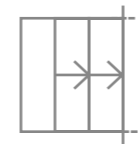

INSIDE OUT 28 | INVISIBLE 51 | REPLACE 72-73

ΠΑΡΑΘΥΡΟ ΔΙΦΥΛΛΟ ΧΩΝΕΥΤΟ ΠΑΡΑΣΥΡΟΜΕΝΟ  
DOUBLE-SASH RECESSED WINDOW

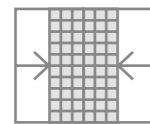

INSIDE OUT 16-18 | INVISIBLE 42-43 | REPLACE 64-65

ΠΑΡΑΘΥΡΟ ΔΙΦΥΛΛΟ ΕΠΑΛΛΗΛΟ ΜΕ ΣΙΤΑ  
DOUBLE-SASH WINDOW ON DOUBLE RAIL WITH MOSQUITO NET

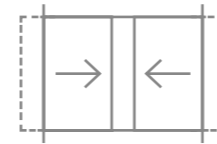

INSIDE OUT 29 | INVISIBLE 52 | REPLACE 74

ΠΑΡΑΘΥΡΟ ΔΙΦΥΛΛΟ ΦΙΛΗΤΟ - ΧΩΝΕΥΤΟ  
DOUBLE-SASH RECESSED WINDOW WITH CENTRAL LOCK

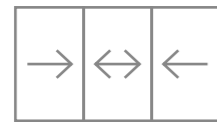

INSIDE OUT 19-21 | INVISIBLE 44-45 | REPLACE 66

ΠΑΡΑΘΥΡΟ ΤΡΙΦΥΛΛΟ ΕΠΑΛΛΗΛΟ  
TRIPLE-SASH WINDOW ON DOUBLE RAIL

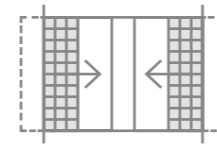

INSIDE OUT 30 | INVISIBLE 53 | REPLACE 75

ΠΑΡΑΘΥΡΟ ΔΙΦΥΛΛΟ ΦΙΛΗΤΟ-ΧΩΝΕΥΤΟ ΜΕ ΣΙΤΑ  
DOUBLE-SASH RECESSED WINDOW WITH CENTRAL LOCK AND MOSQUITO NET

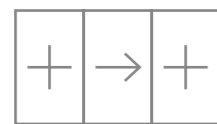

INSIDE OUT 22 | INVISIBLE 46 | REPLACE 67-68

ΠΑΡΑΘΥΡΟ ΤΡΙΦΥΛΛΟ ΣΕ ΔΙΠΛΟ ΟΔΗΓΟ ΜΕ ΕΝΑ ΚΙΝΗΤΟ ΦΥΛΛΟ  
TRIPLE-SASH WINDOW ON DOUBLE RAIL WITH ONE MOVING SASH



INSIDE OUT 31-33 | INVISIBLE 54-55 | REPLACE 76-77

ΠΑΡΑΘΥΡΟ ΠΕΝΤΑΦΥΛΛΟ  
FIVE-SASH WINDOW



INSIDE OUT 23-24 | INVISIBLE 47-48 | REPLACE 69-70

ΠΑΡΑΘΥΡΟ ΜΟΝΟΦΥΛΛΟ ΧΩΝΕΥΤΟ  
SINGLE-SASH RECESSED WINDOW

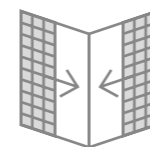

INSIDE OUT 34 | INVISIBLE 56 | REPLACE 78

ΠΑΡΑΘΥΡΟ ΓΩΝΙΑΚΟ ΜΕ ΣΙΤΑ  
CORNER WINDOW WITH MOSQUITO NET







# SPACE Inside Out

SECTION

## 1.a

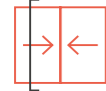

TYPOLGY  
ΠΑΡΑΘΥΡΟ ΔΙΦΥΛΛΟ  
ΕΠΑΛΛΗΛΟ  
DOUBLE-SASH WINDOW

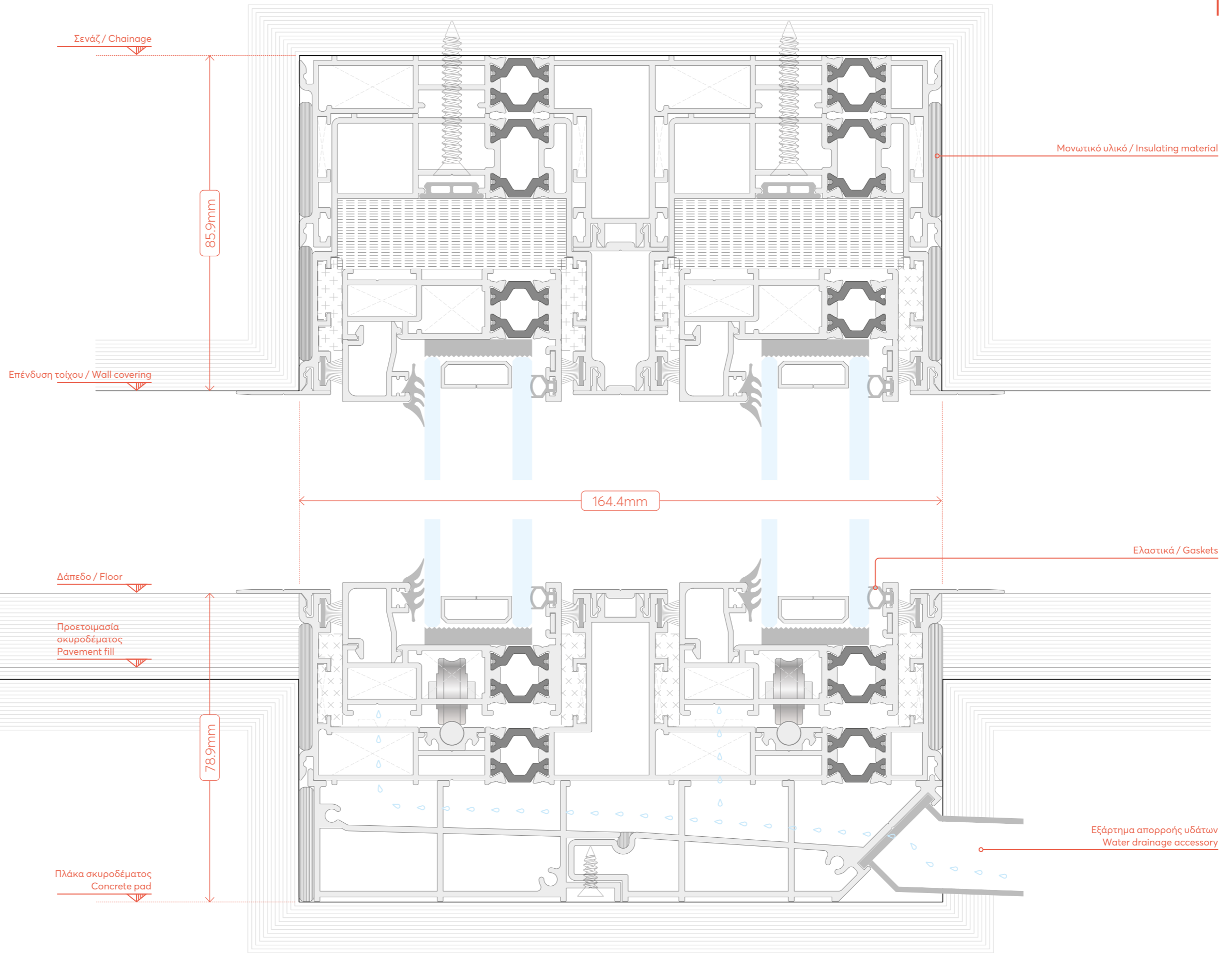

# SPACE Inside Out

SECTION

## 1.b



TYPOLGY  
ΠΑΡΑΘΥΡΟ ΔΙΦΥΛΛΟ  
ΕΠΑΛΛΗΛΟ ΜΕ ΣΧΑΡΑ  
DOUBLE-SASH WINDOW  
WITH GRATE

INSIDE OUT

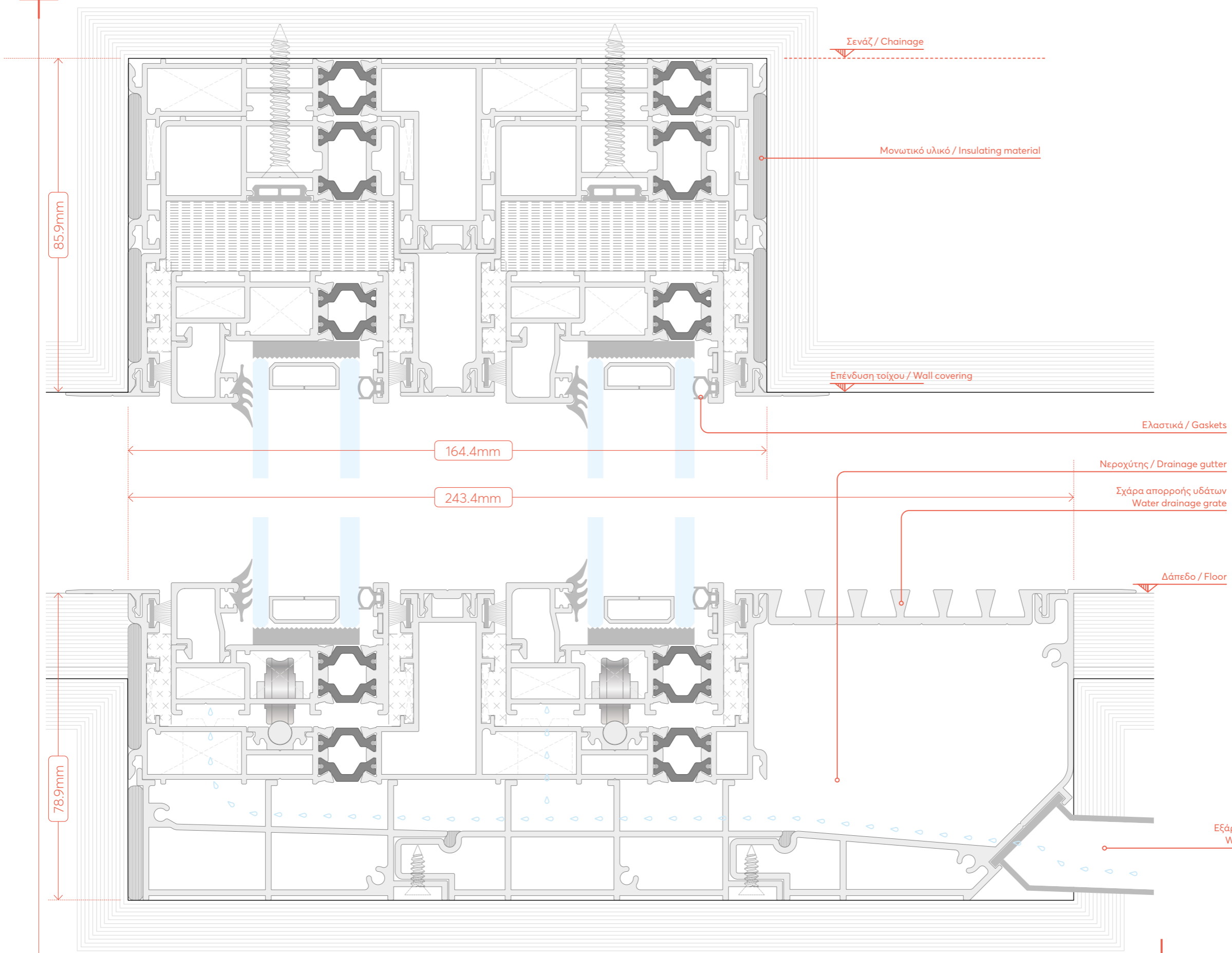

DESIGN SCALE 1:1



# SPACE Inside Out

SECTION

## 2.0

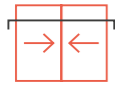

TYPOLGY  
ΠΑΡΑΘΥΡΟ ΔΙΦΥΛΛΟ  
ΕΠΑΛΛΗΛΟ  
DOUBLE-SASH WINDOW

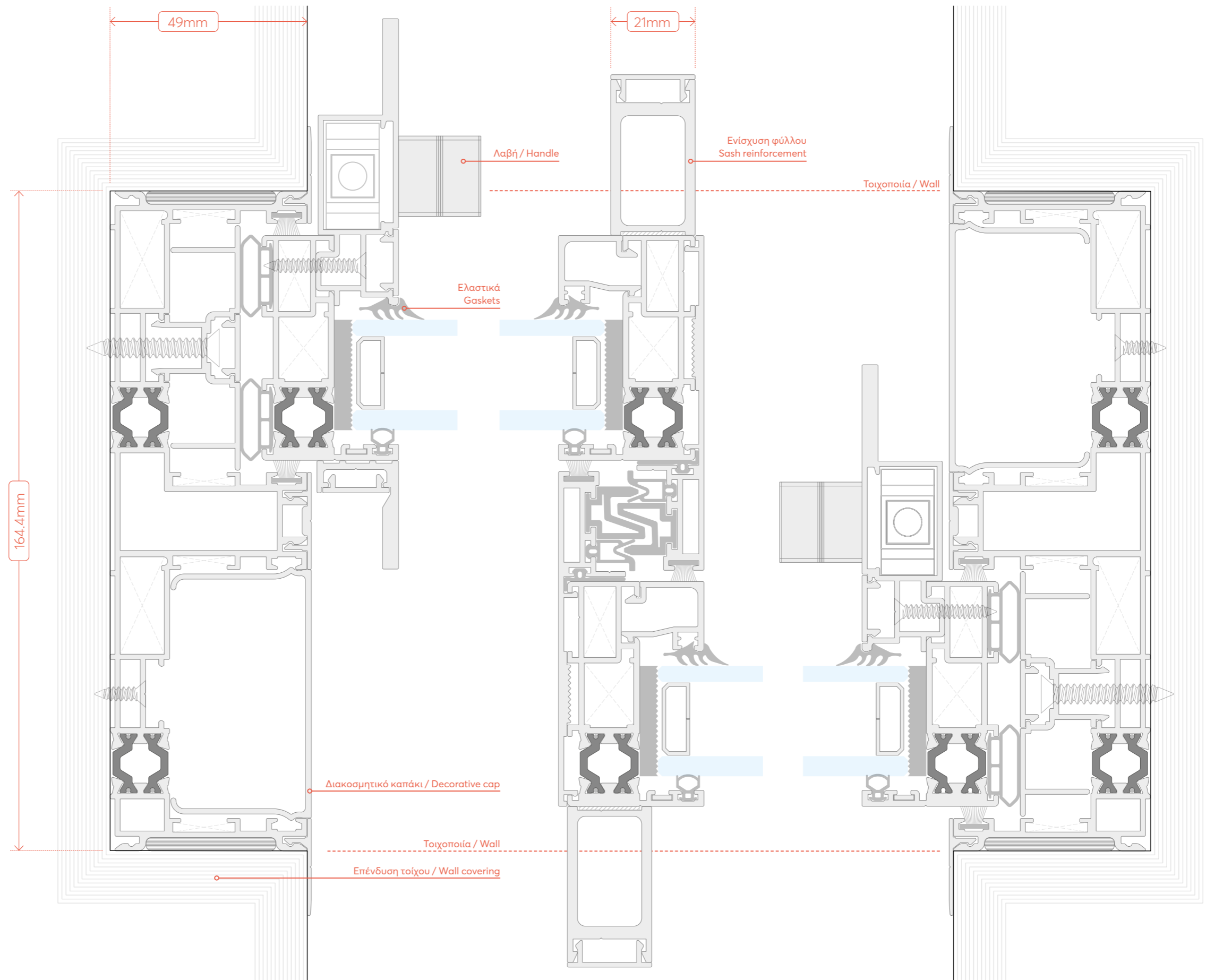

# SPACE Inside Out

SECTION

## 3.a

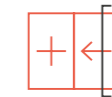

TYPOLOGY  
ΠΑΡΑΘΥΡΟ ΔΙΦΥΛΛΟ ΜΕ  
ΕΝΑ ΦΥΛΛΟ ΣΤΑΘΕΡΟ  
DOUBLE-SASH WINDOW  
WITH ONE FIXED SASH

INSIDE OUT

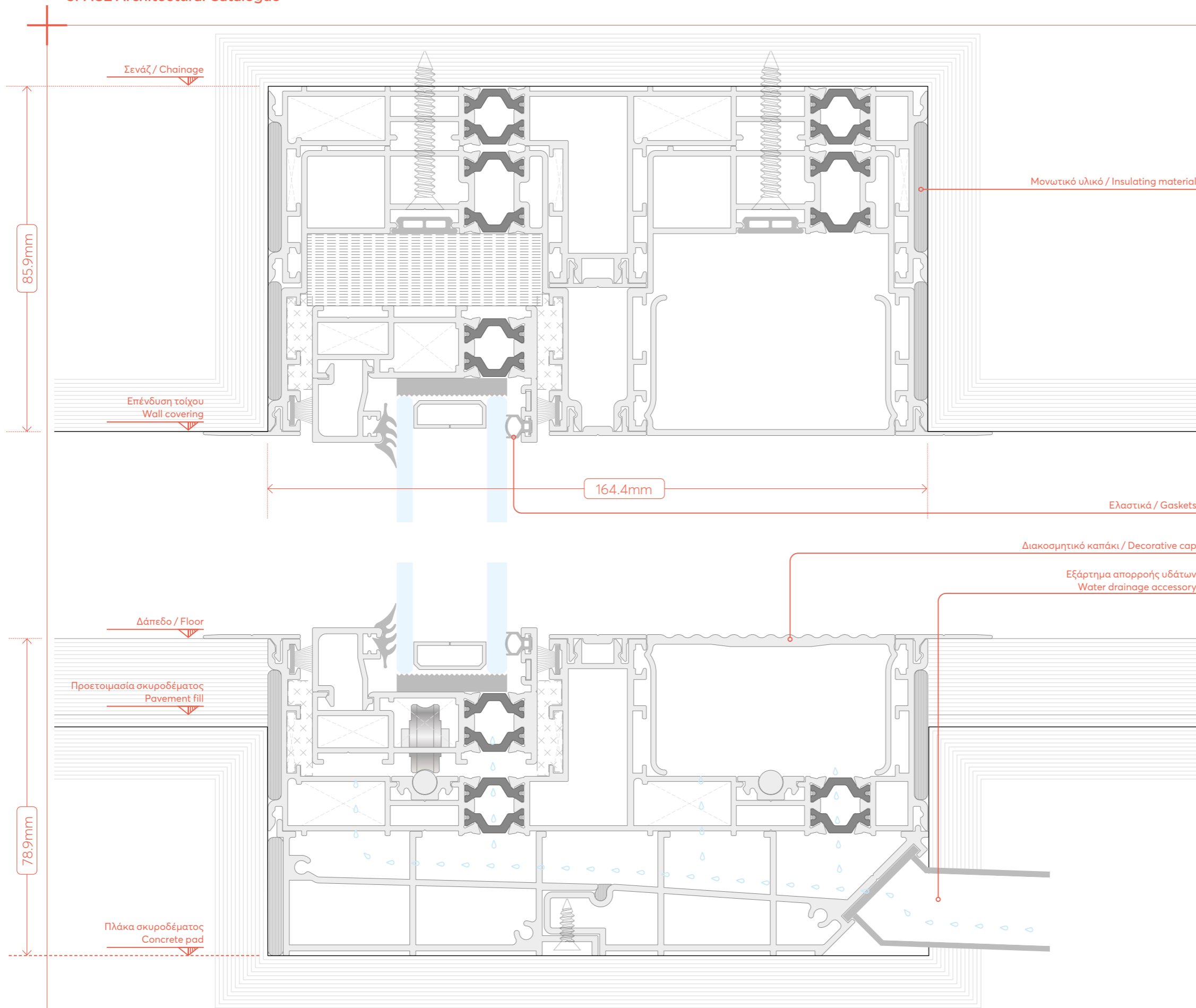

DESIGN SCALE 1:1

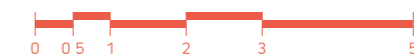

# SPACE Inside Out

SECTION

## 3.b

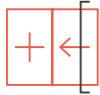

**TYPOLGY**  
ΠΑΡΑΘΥΡΟ ΔΙΦΥΛΛΟ ΜΕ  
ΕΝΑ ΦΥΛΛΟ ΣΤΑΘΕΡΟ  
ΚΑΙ ΝΕΡΟΧΥΤΗ  
DOUBLE-SASH WINDOW  
WITH ONE FIXED SASH  
AND GUTTER

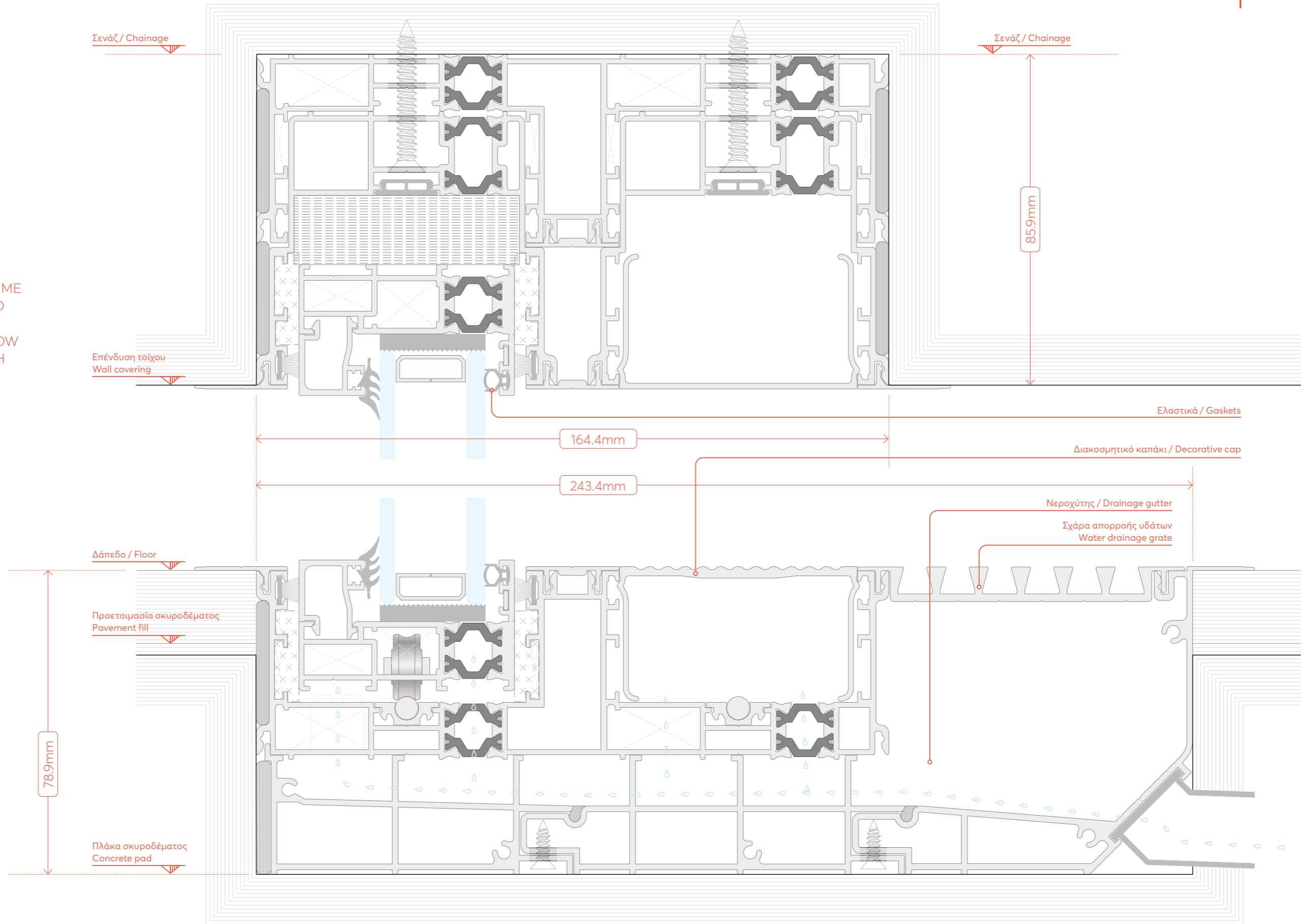

# SPACE Inside Out

SECTION

## 4.0

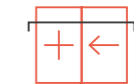

TYPOLGY  
ΠΑΡΑΘΥΡΟ ΔΙΦΥΛΛΟ ΜΕ  
ΕΝΑ ΦΥΛΛΟ ΣΤΑΘΕΡΟ  
DOUBLE-SASH WINDOW  
WITH ONE FIXED SASH

INSIDE OUT

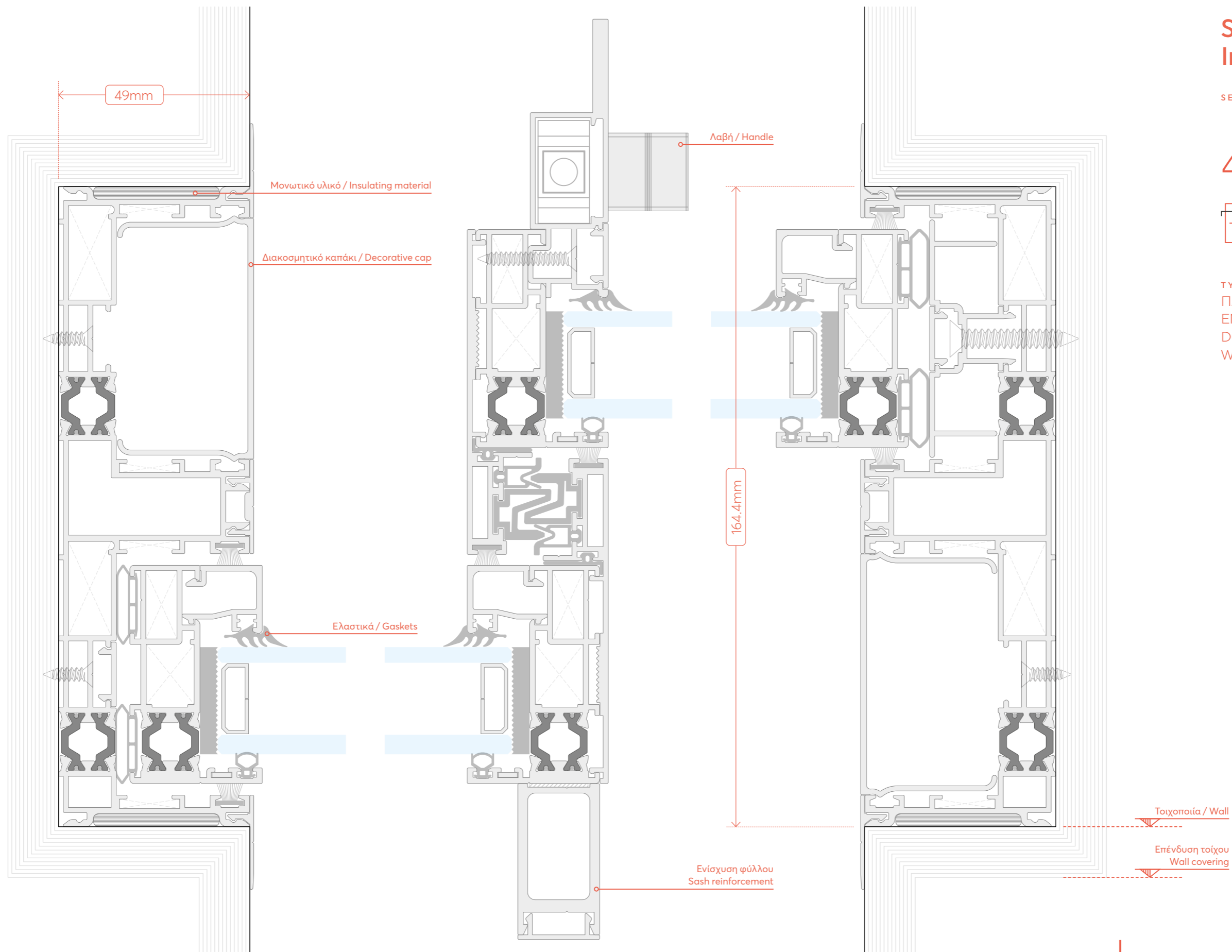

DESIGN SCALE 1:1



# SPACE Inside Out

SECTION

## 5.a

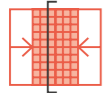

TYPOLOGY  
ΠΑΡΑΘΥΡΟ ΔΙΦΥΛΛΟ  
ΜΕ ΣΙΤΑ  
DOUBLE-SASH WINDOW  
WITH MOSQUITO NET

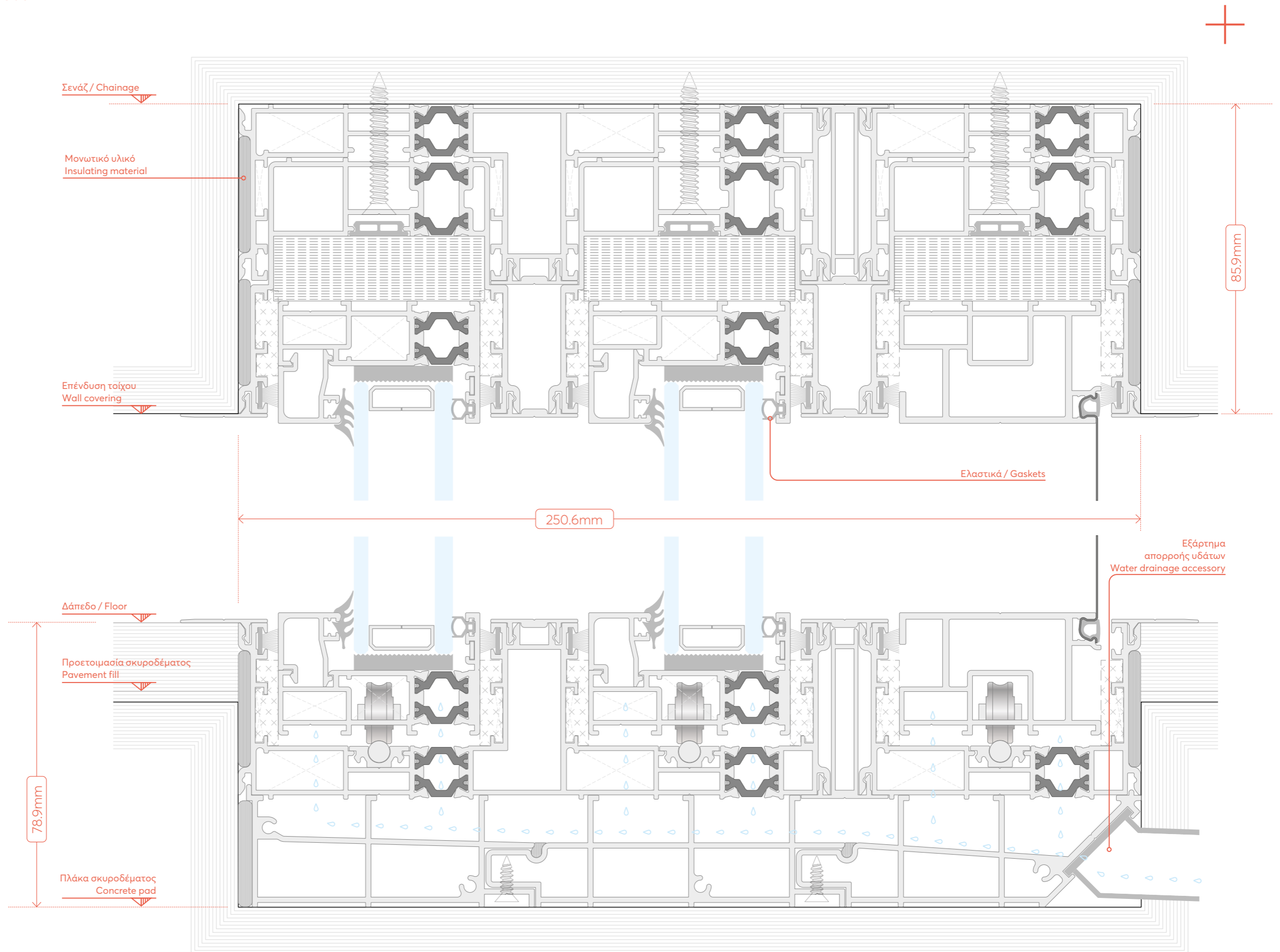



# SPACE Inside Out

SECTION

## 5.b

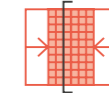

ΤΥΠΟΛΟΓΙΑ  
ΠΑΡΑΘΥΡΟ ΔΙΦΥΛΛΟ  
ΕΠΑΛΛΗΛΟ ΜΕ ΣΙΤΑ ΚΑΙ  
ΣΧΑΡΑ  
DOUBLE-SASH WINDOW  
WITH MOSQUITO NET  
AND GRATE

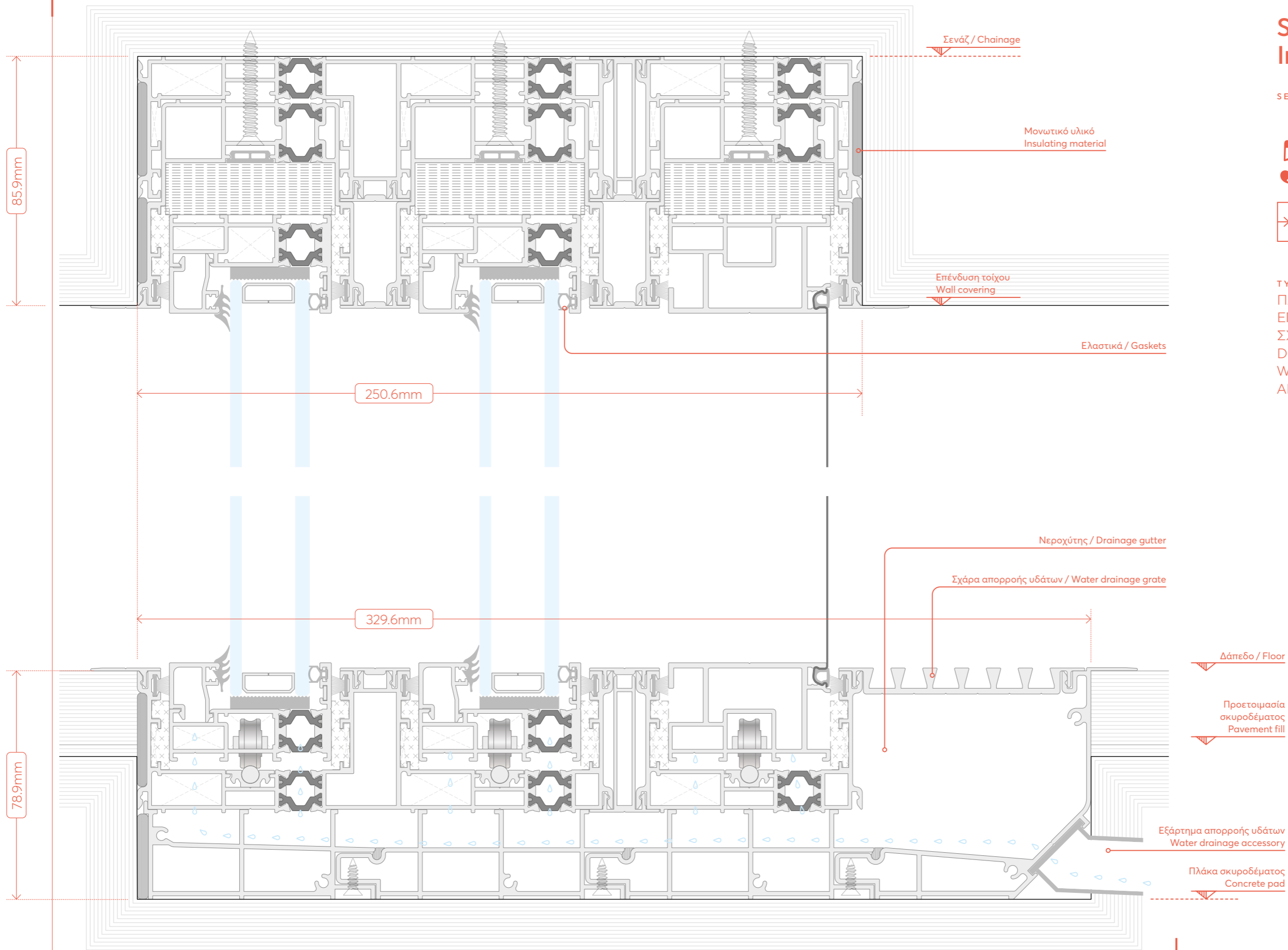

DESIGN SCALED TO FIT

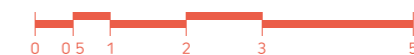

# SPACE Inside Out

SECTION

## 6.0

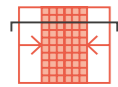

TYPOLGY  
ΠΑΡΑΘΥΡΟ ΔΙΦΥΛΛΟ  
ΜΕ ΣΙΤΑ  
DOUBLE-SASH WINDOW  
WITH MOSQUITO NET

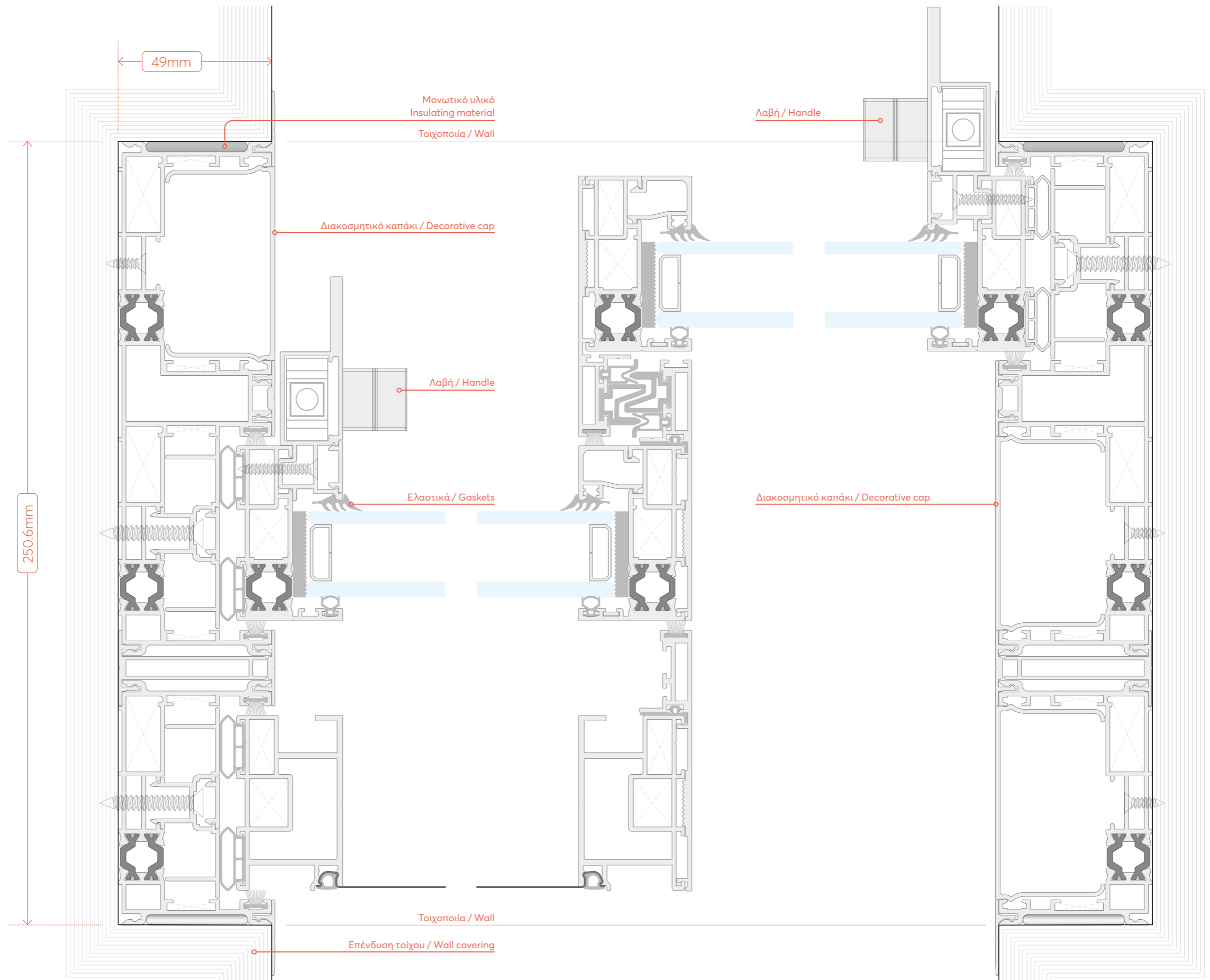

# SPACE Inside Out

SECTION

## 7.a

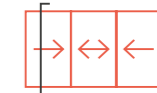

TYPOLGY  
ΠΑΡΑΘΥΡΟ ΤΡΙΦΥΛΛΟ  
TRIPLE-SASH WINDOW

Σενάζ / Chainage

Μονωτικό υλικό  
Insulating material

Επένδυση τοίχου  
Wall covering

Ελαστικά / Gaskets

85.9mm

Επένδυση τοίχου  
Wall covering

250.6mm

78.9mm

Δάπεδο / Floor

Προετοιμασία  
σκυροδέματος  
Pavement fill

Εξάρτημα απορροής υδάτων  
Water drainage accessory

Πλάκα σκυροδέματος  
Concrete pad

DESIGN SCALE 1:1



# SPACE Inside Out

SECTION

## 7.b

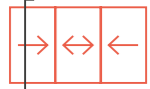

TYPOLOGY  
ΠΑΡΑΘΥΡΟ ΤΡΙΦΥΛΛΟ  
ΜΕ ΣΧΑΡΑ  
TRIPLE-SASH WINDOW  
WITH GRATE

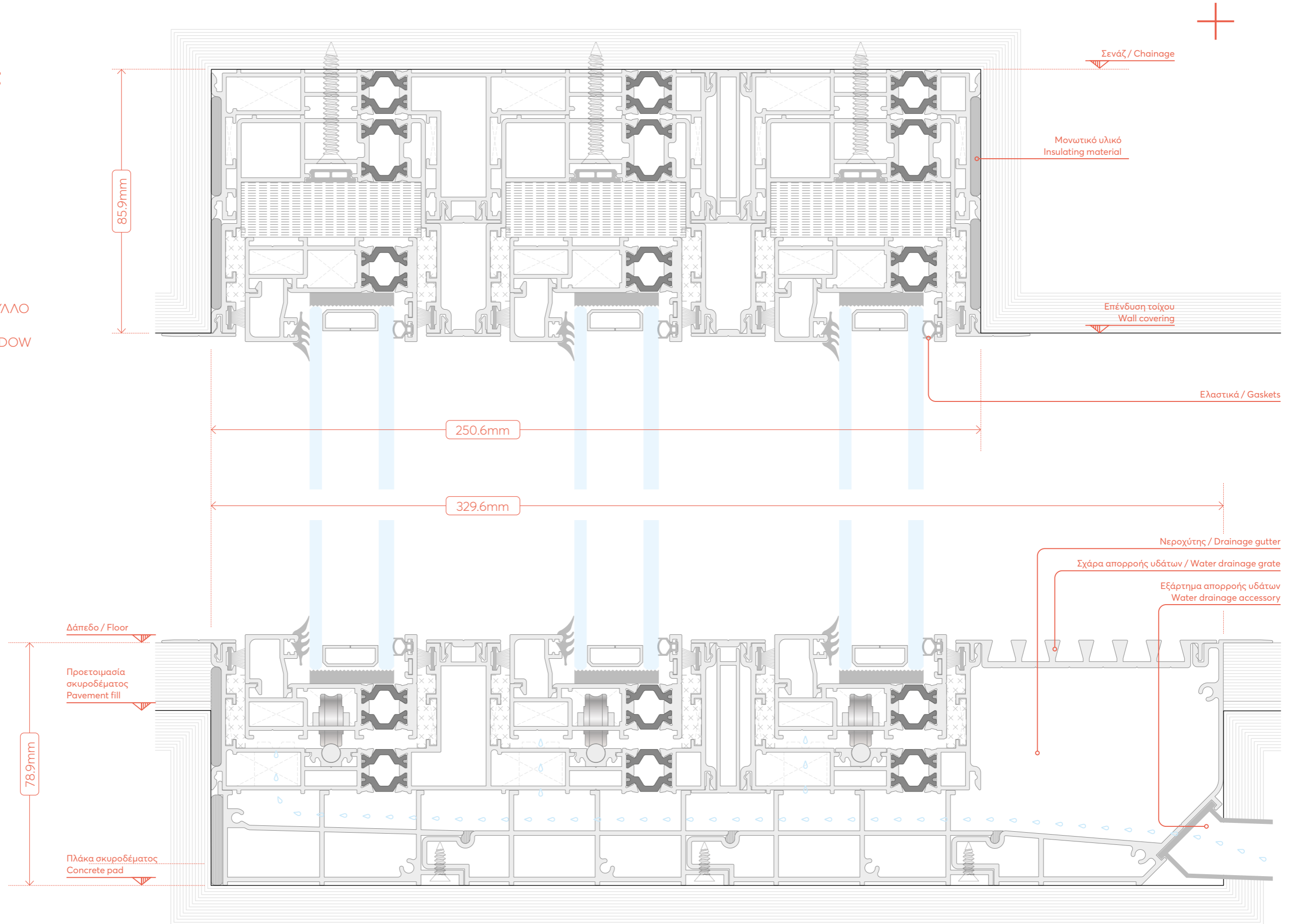

# SPACE Inside Out

SECTION

## 8.0

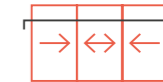

TYPOLGY  
ΠΑΡΑΘΥΡΟ ΤΡΙΦΥΛΛΟ  
TRIPLE-SASH WINDOW

INSIDE OUT

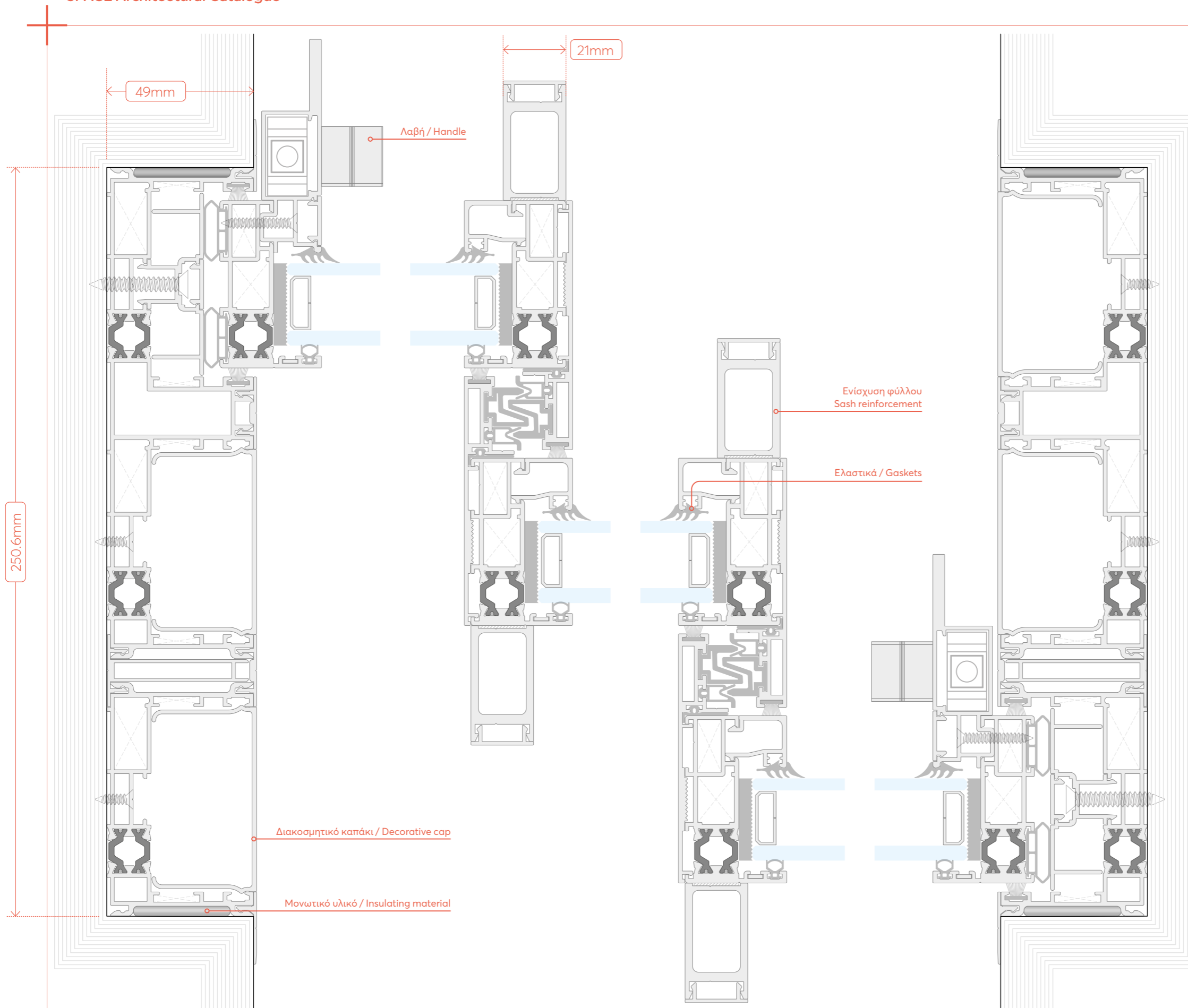

DESIGN SCALED TO FIT

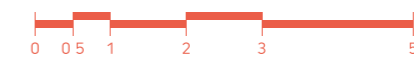

# SPACE Inside Out

SECTION

## 9.0

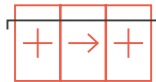

**TYPOLGY**  
ΠΑΡΑΘΥΡΟ ΤΡΙΦΥΛΛΟ  
ΜΕ ΕΝΑ ΚΙΝΗΤΟ ΦΥΛΛΟ  
TRIPLE-SASH WINDOW  
ON DOUBLE RAIL WITH  
ONE MOVING SASH

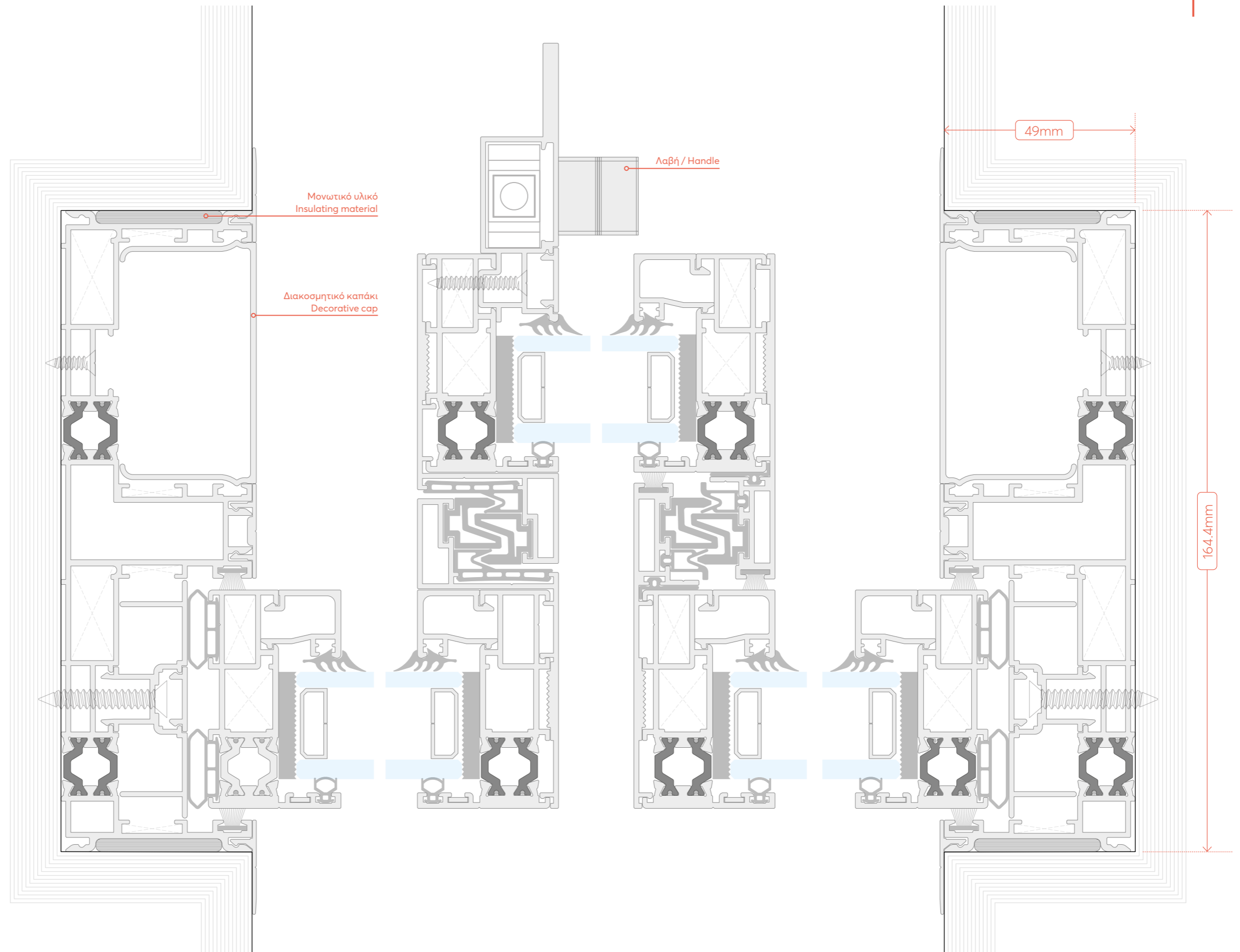

SPACE  
Inside Out

SECTION

10.a



ΤΥΠΟΛΟΓΗ  
ΠΑΡΑΘΥΡΟ  
ΜΟΝΟΦΥΛΛΟ  
ΧΩΝΕΥΤΟ  
SINGLE-SASH  
RECESSED  
WINDOW

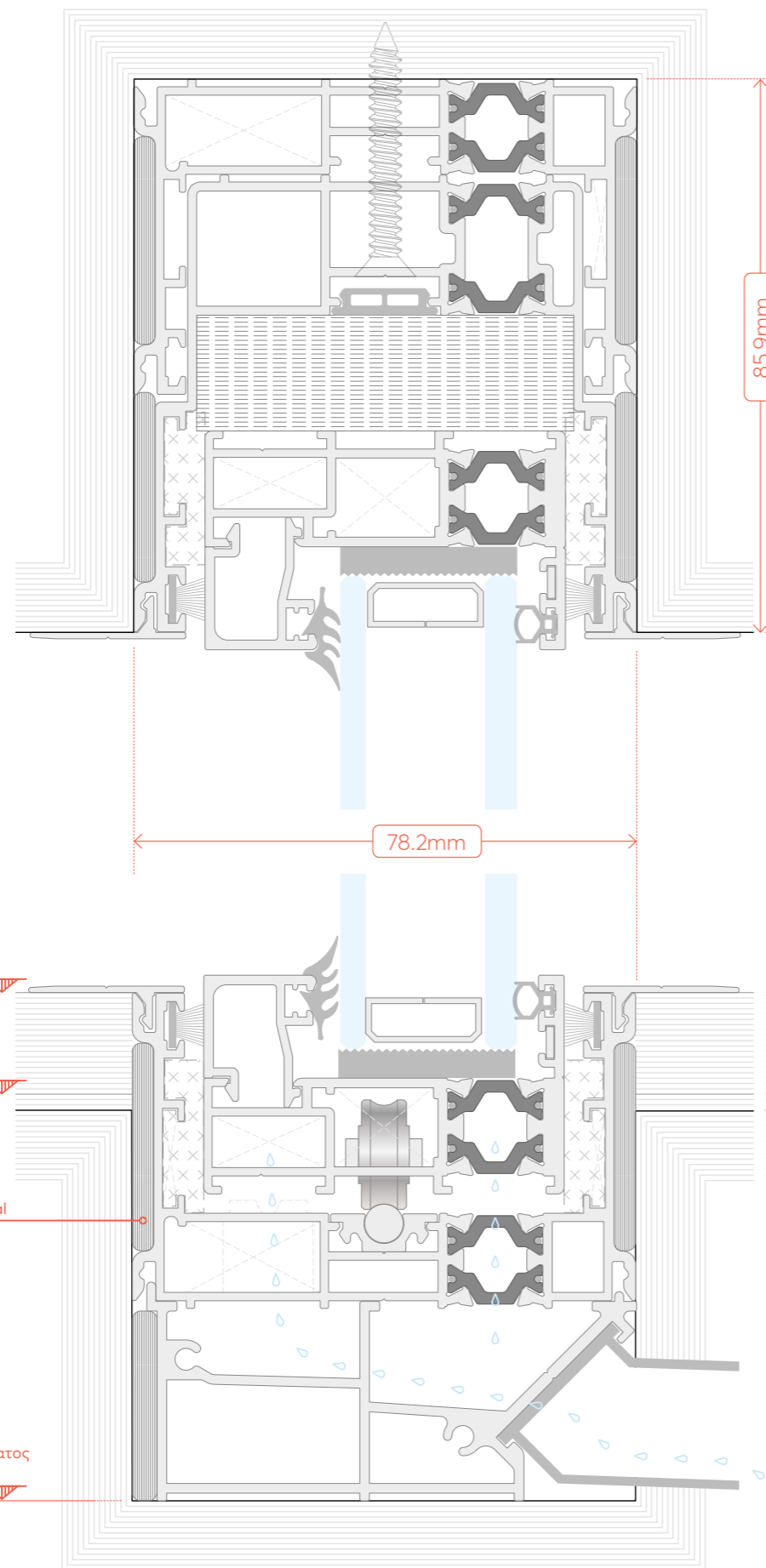

SPACE  
Inside Out

SECTION

10.b



ΤΥΠΟΛΟΓΗ  
ΠΑΡΑΘΥΡΟ  
ΜΟΝΟΦΥΛΛΟ  
ΧΩΝΕΥΤΟ ΜΕ  
ΣΧΑΡΑ  
SINGLE-SASH  
RECESSED WINDOW  
WITH GRATE

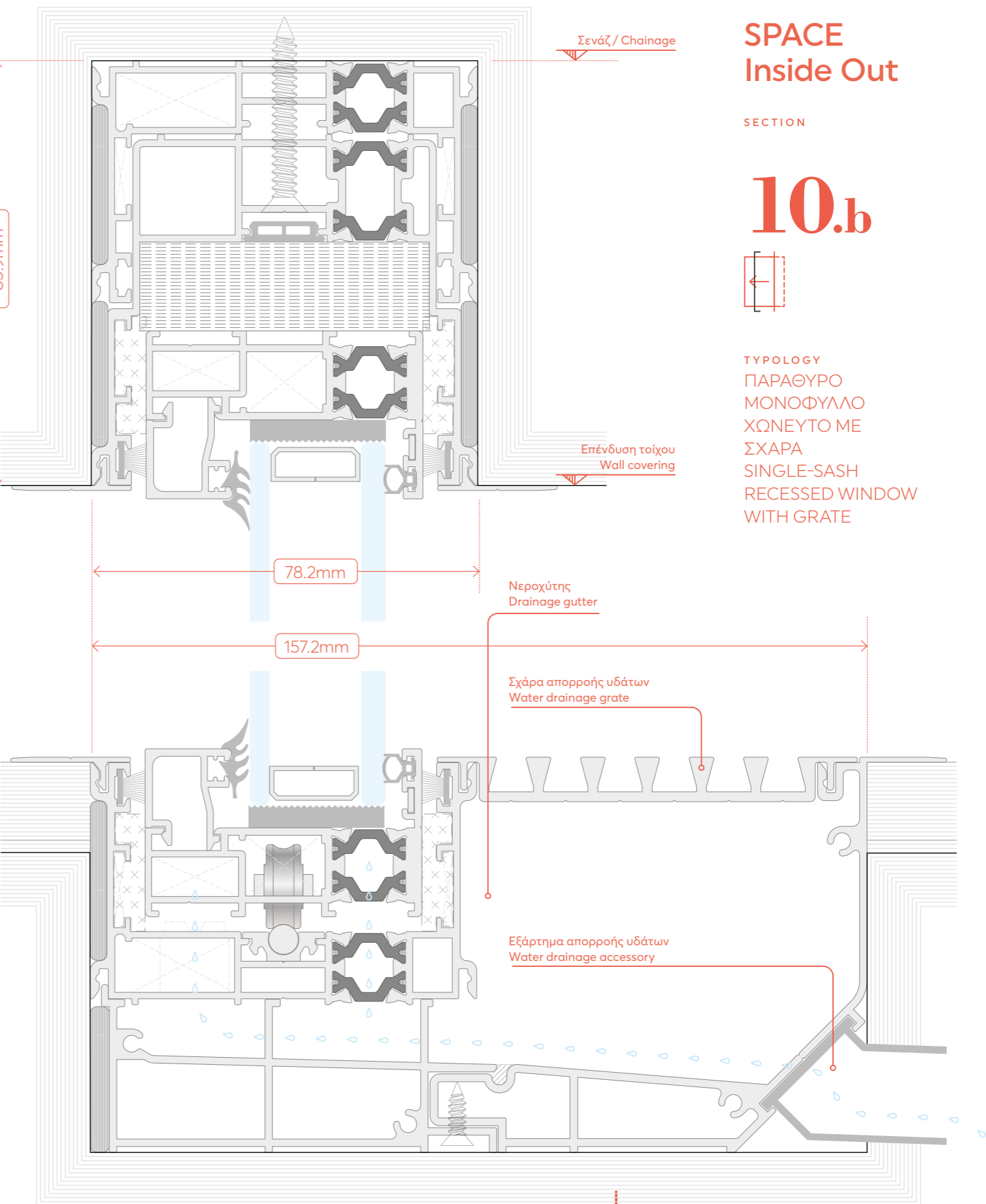

# SPACE Inside Out

SECTION

# 11.0



ΤΥΠΟΛΟΓΙΑ  
ΠΑΡΑΘΥΡΟ  
ΜΟΝΟΦΥΛΛΟ ΧΩΝΕΥΤΟ  
SINGLE-SASH RECESSED  
WINDOW

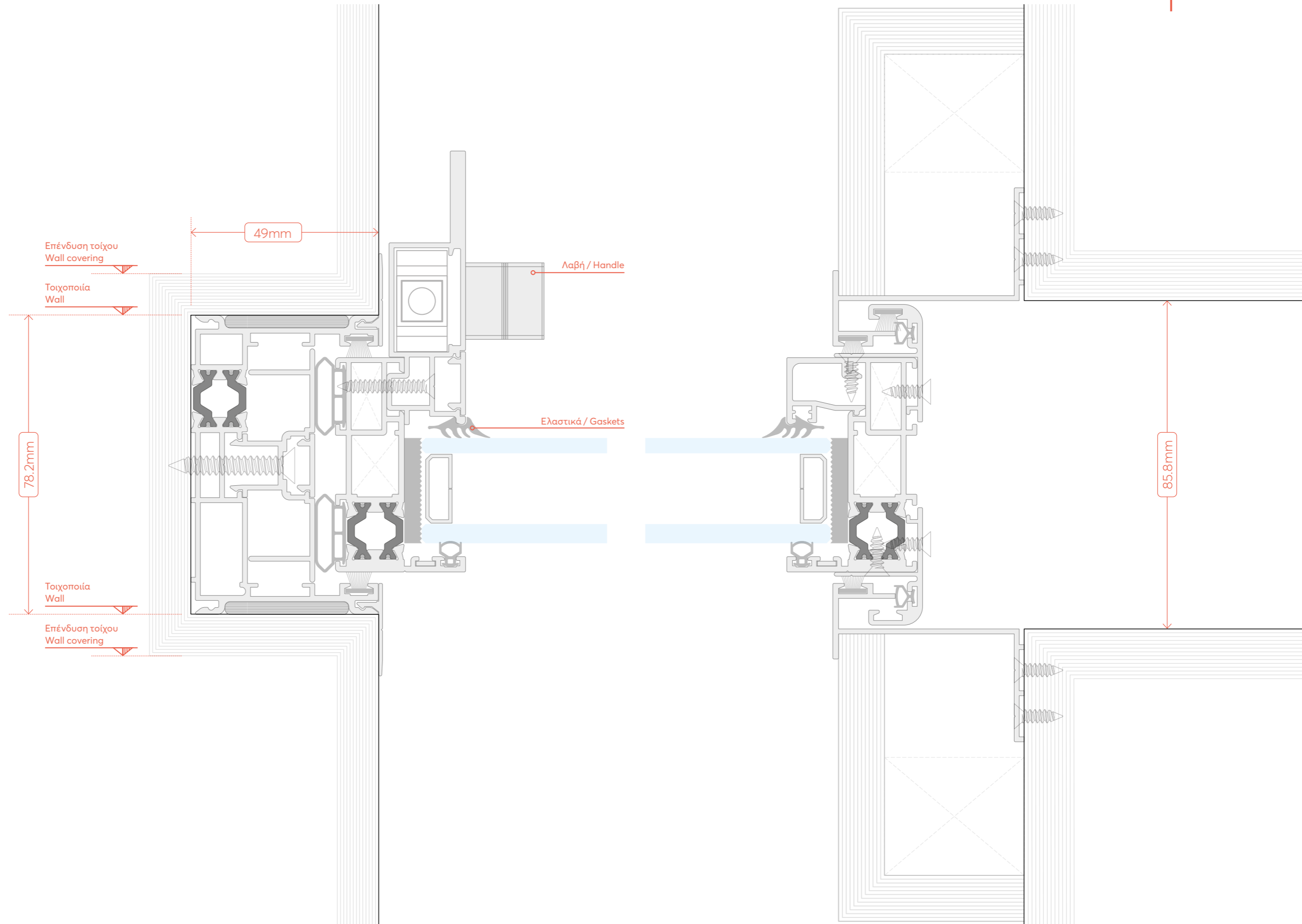



# SPACE Inside Out

SECTION

## 12.a

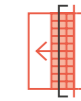

TPOLOGY  
ΠΑΡΑΘΥΡΟ  
ΜΟΝΟΦΥΛΛΟ  
ΧΩΝΕΥΤΟ ΜΕ ΣΙΤΑ  
SINGLE-SASH  
RECESSED WINDOW  
WITH MOSQUITO NET

INSIDE OUT

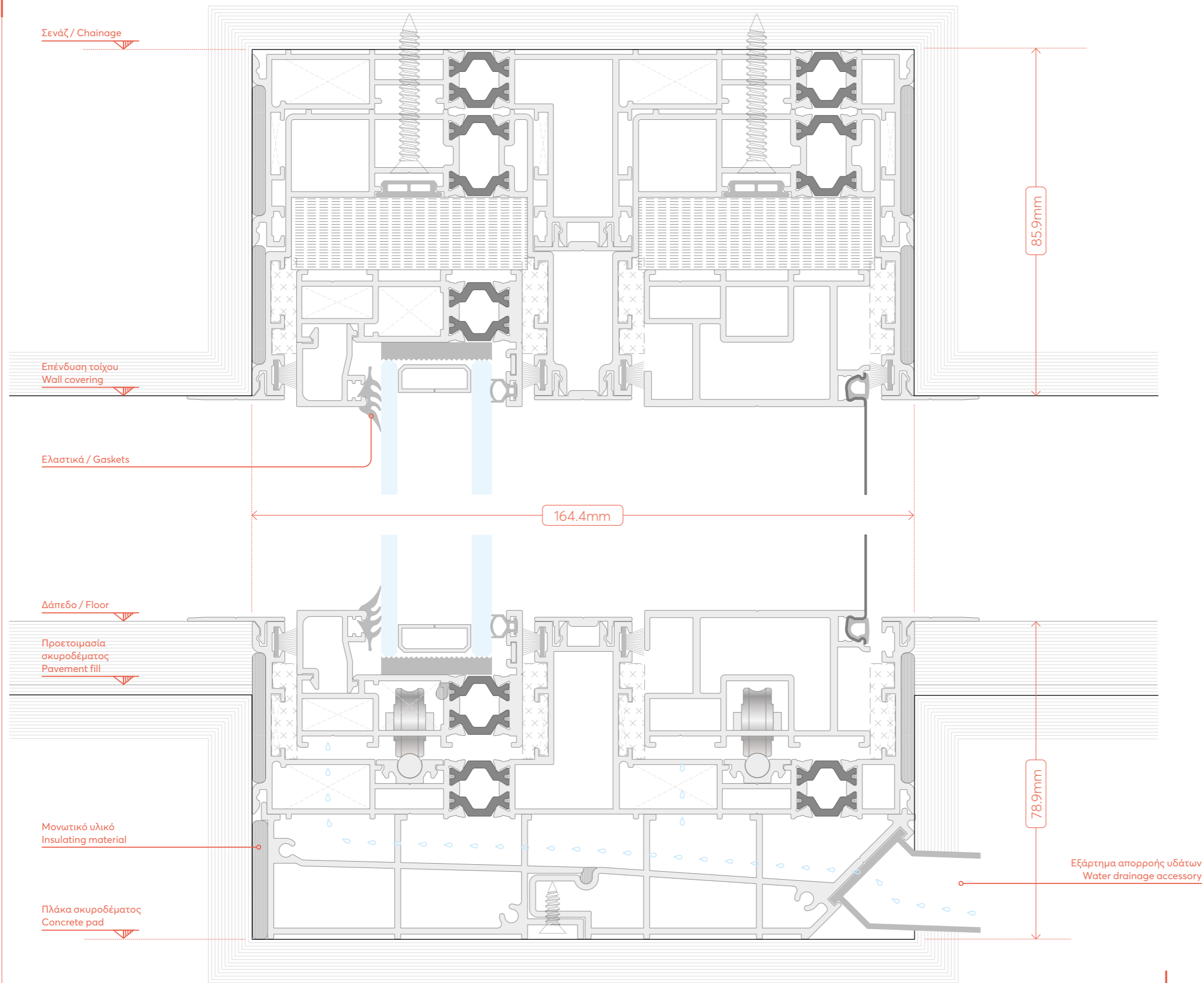

DESIGN SCALE 1:1

DESIGN SCALE

1:1

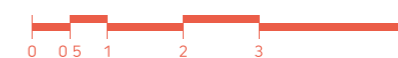

# SPACE Inside Out

SECTION

## 12.b



TYPOLOGY  
ΠΑΡΑΘΥΡΟ  
ΜΟΝΟΦΥΛΛΟ ΧΩΝΕΥΤΟ  
ΜΕ ΣΙΤΑ ΚΑΙ ΣΧΑΡΑ  
SINGLE-SASH RECESSED  
WINDOW WITH GRATE  
AND MOSQUITO NET

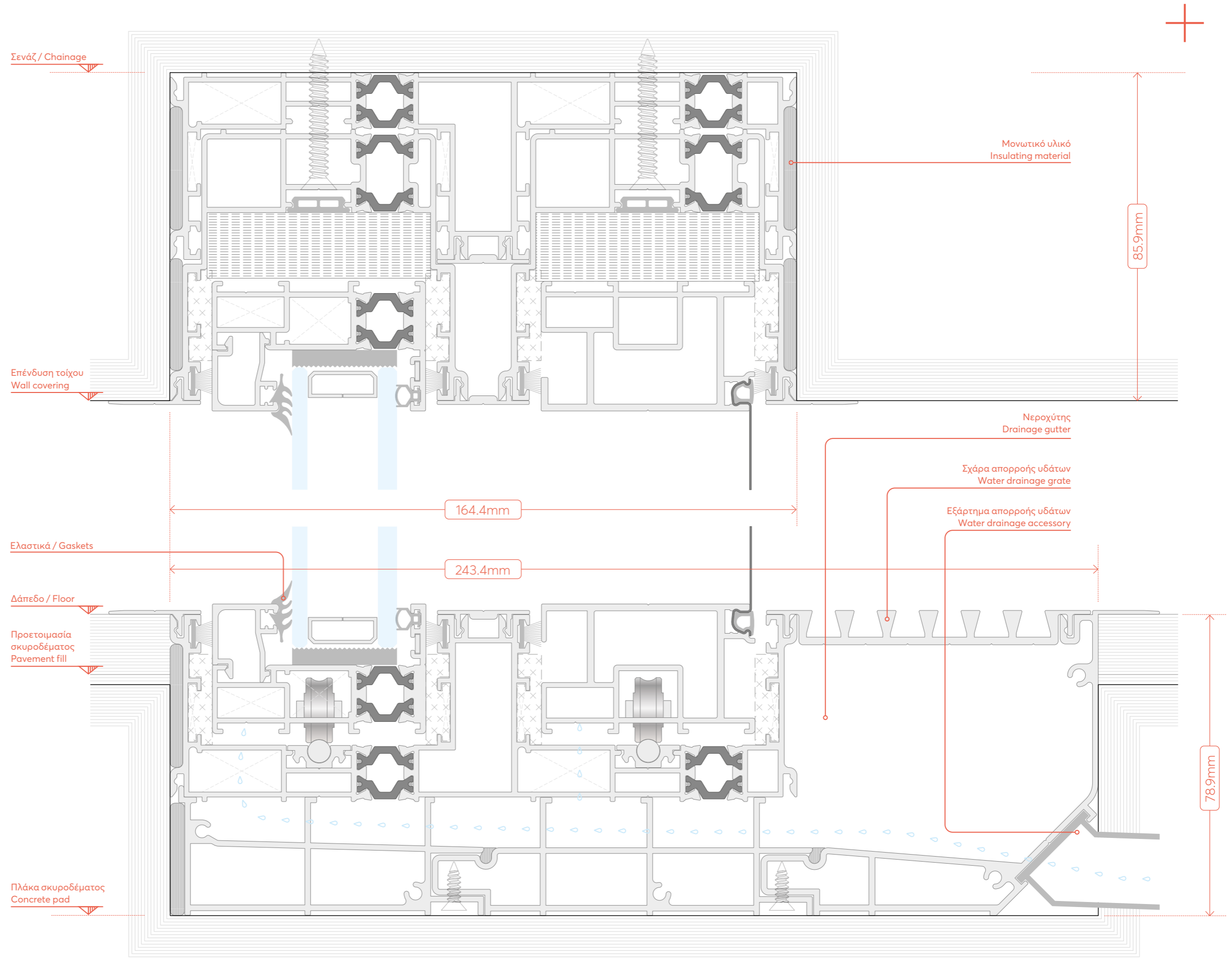

# SPACE Inside Out

SECTION

# 13.0



TPOLOGY  
ΠΑΡΑΘΥΡΟ  
ΜΟΝΟΦΥΛΛΟ  
ΧΩΝΕΥΤΟ ΜΕ ΣΙΤΑ  
SINGLE-SASH  
RECESSED WINDOW  
WITH MOSQUITO NET

INSIDE OUT

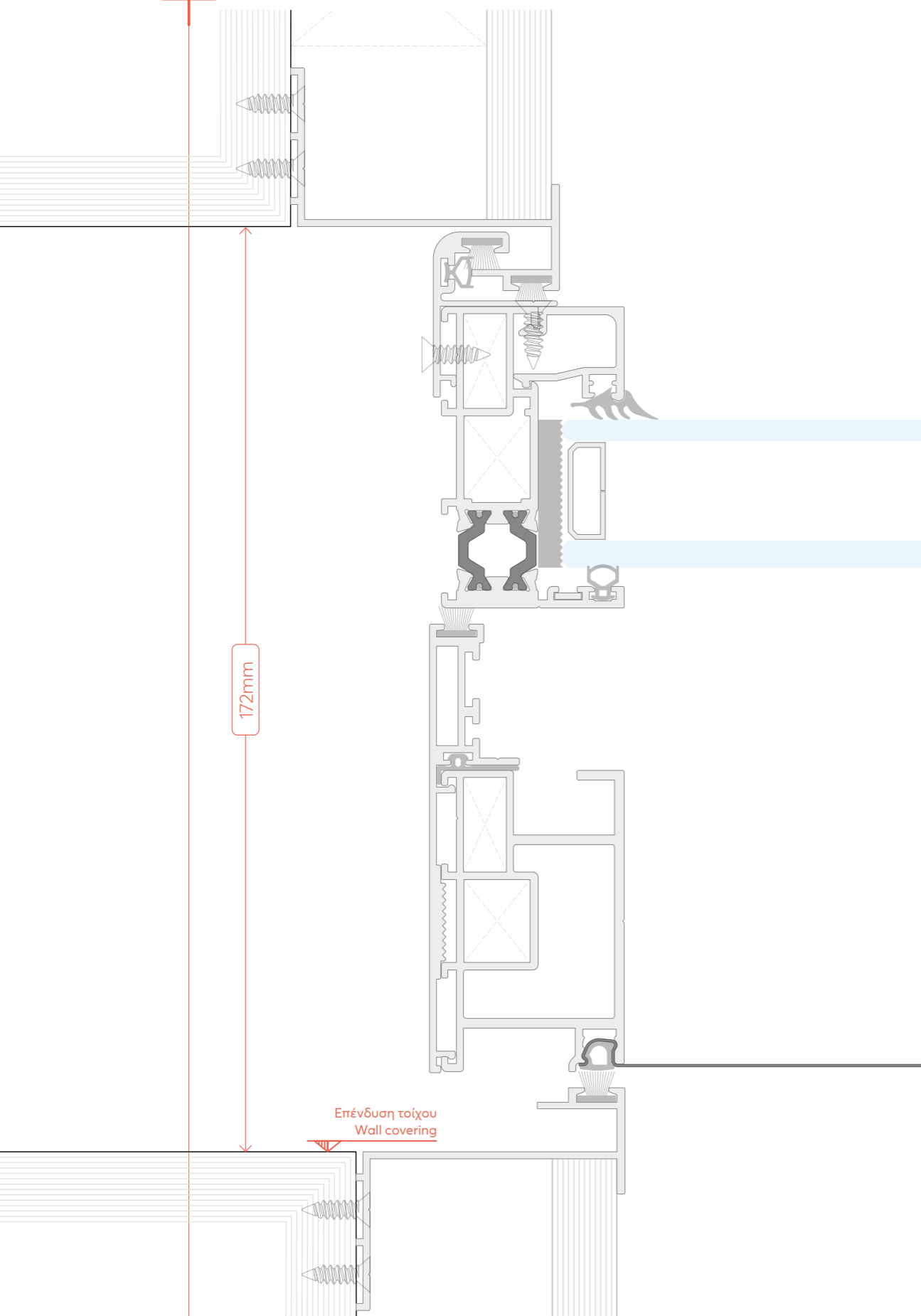

DESIGN SCALE 1:1

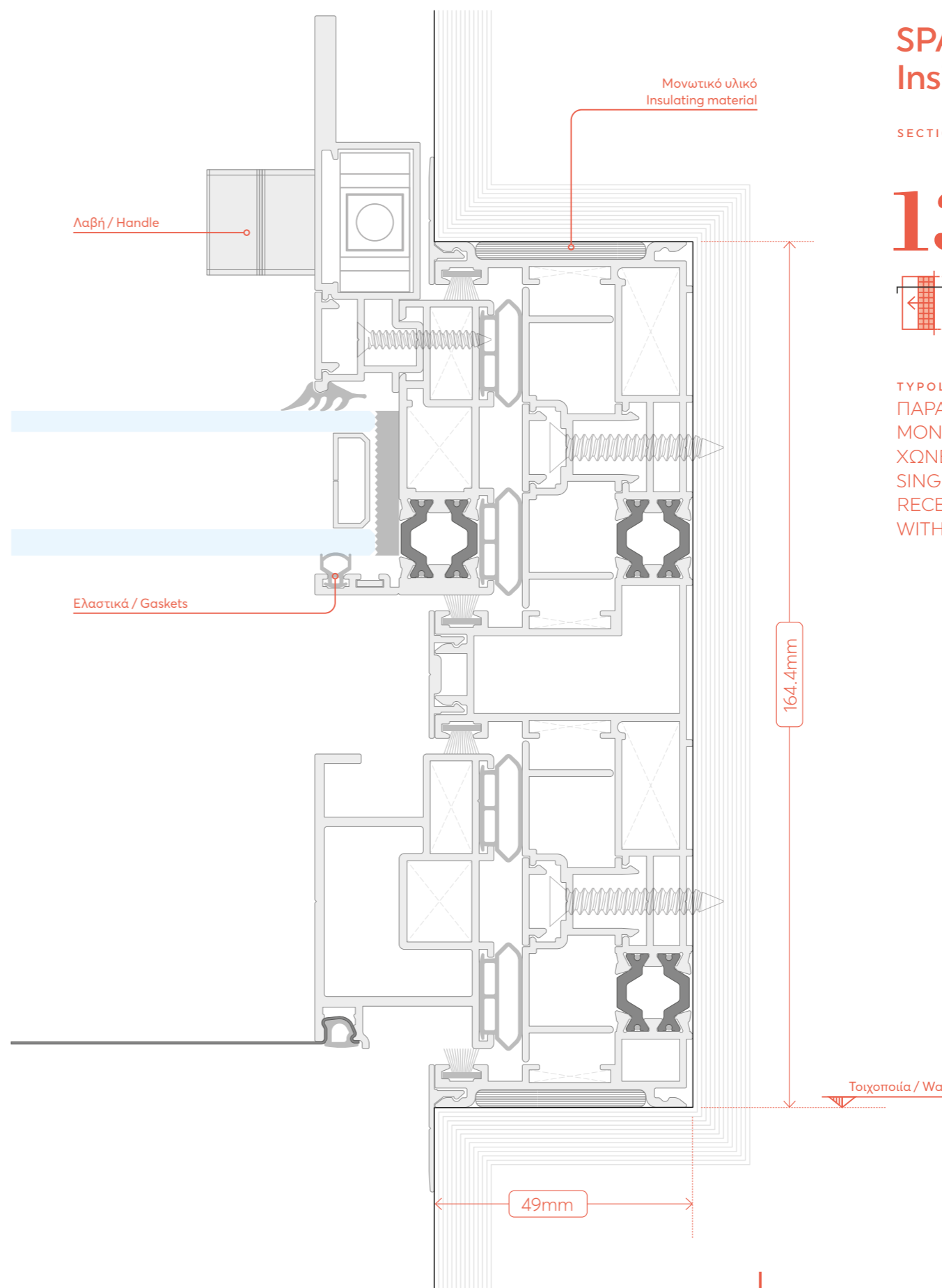

# SPACE Inside Out

SECTION

# 14.0

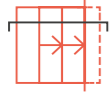

TYPOLGY  
ΠΑΡΑΘΥΡΟ ΔΙΦΥΛΛΟ  
ΧΩΝΕΥΤΟ  
ΠΑΡΑΣΥΡΟΜΕΝΟ  
DOUBLE-SASH RECESSED  
WINDOW

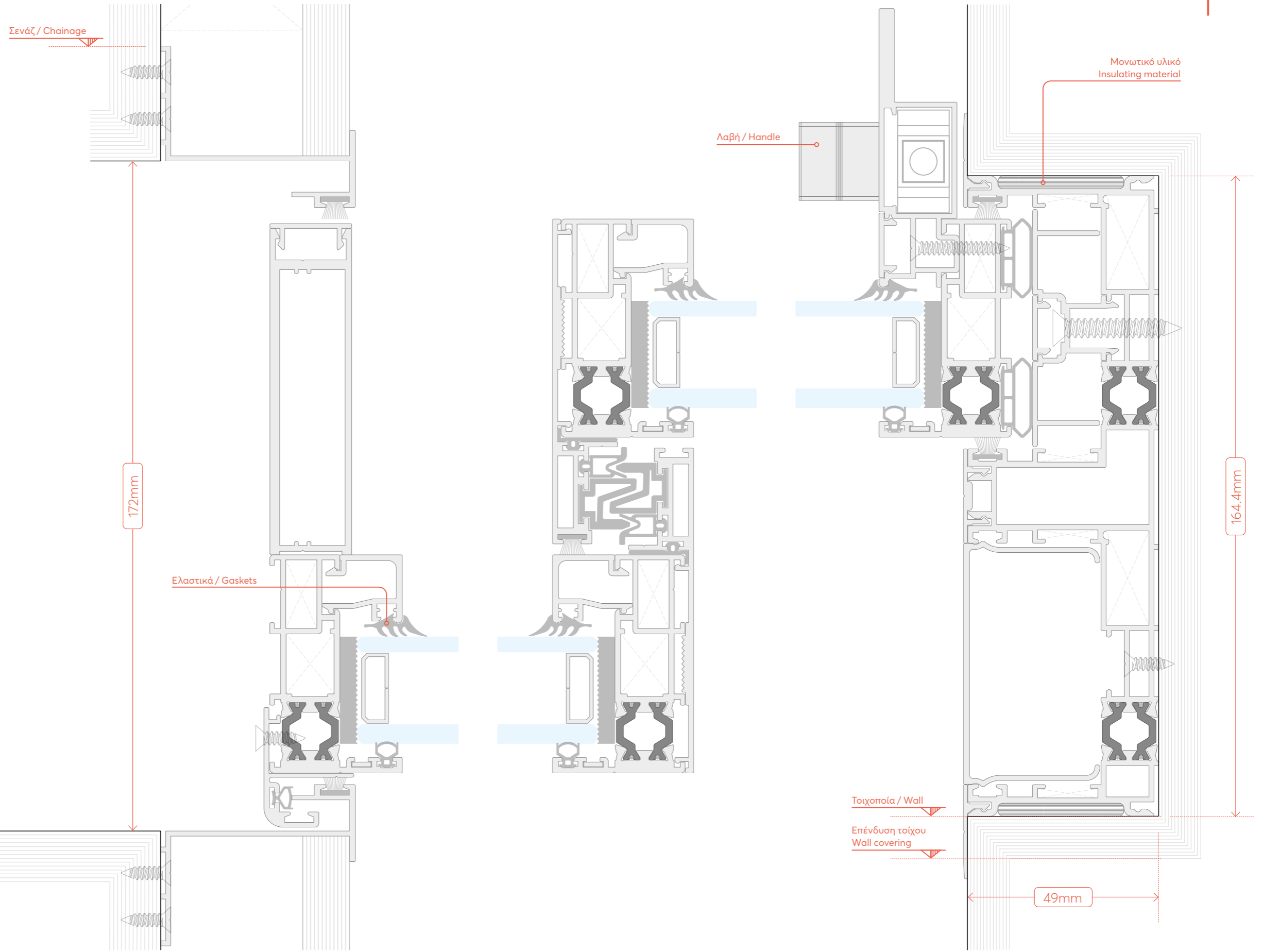

# SPACE Inside Out

SECTION

# 15.0

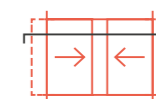

TYPOLGY  
ΠΑΡΑΘΥΡΟ ΔΙΦΥΛΛΟ  
ΦΙΛΗΤΟ ΧΩΝΕΥΤΟ  
DOUBLE-SASH  
RECESSED WINDOW  
WITH CENTRAL LOCK

INSIDE OUT

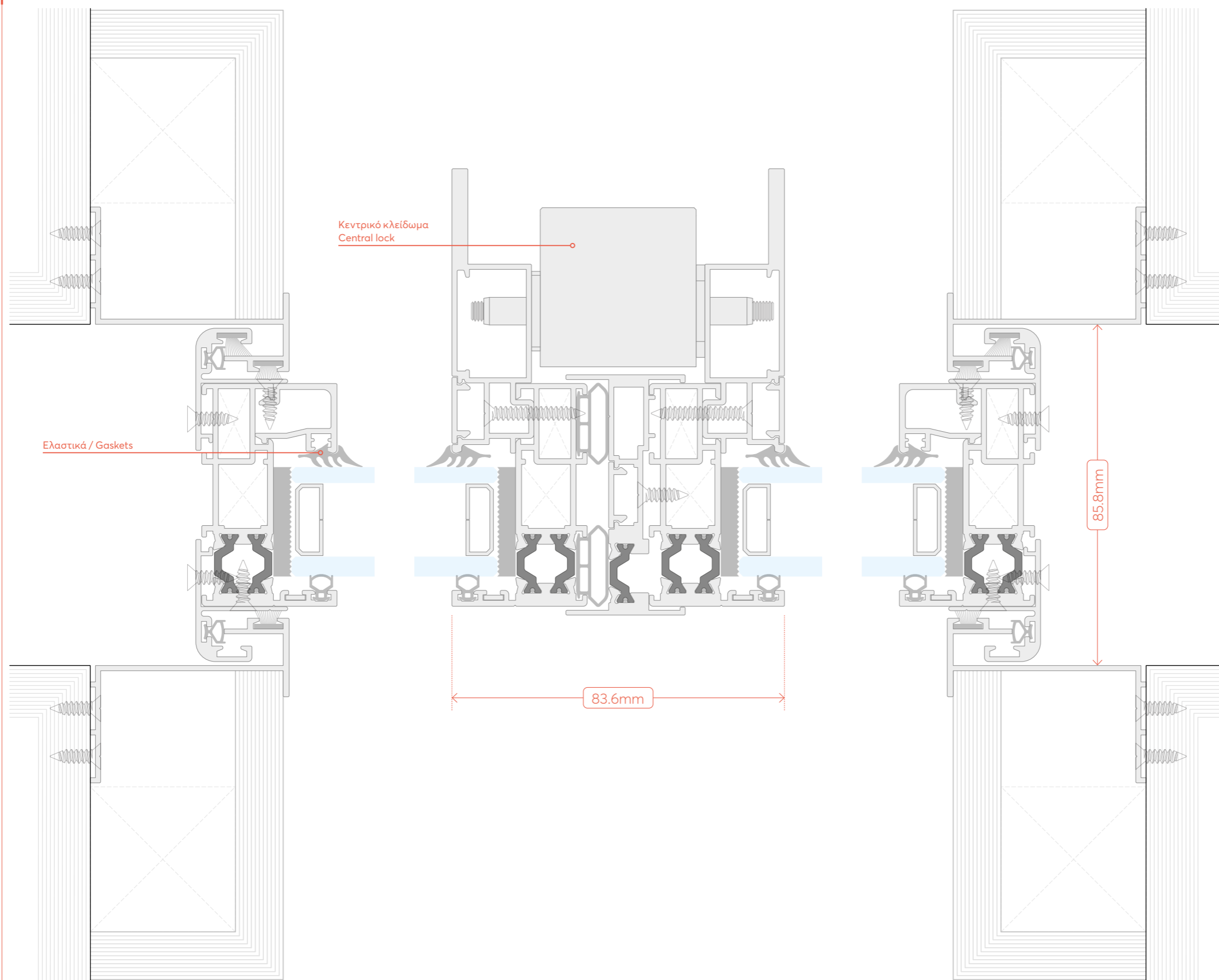

DESIGN SCALED TO FIT



# SPACE Inside Out

SECTION

# 16.0

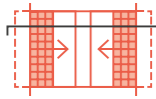

ΤΥΠΟΛΟΓΙΑ  
ΠΑΡΑΘΥΡΟ ΔΙΦΥΛΛΟ  
ΧΩΝΕΥΤΟ ΦΙΛΗΤΟ  
ΜΕ ΣΙΤΑ  
DOUBLE-SASH  
RECESSED WINDOW  
WITH MOSQUITO NET

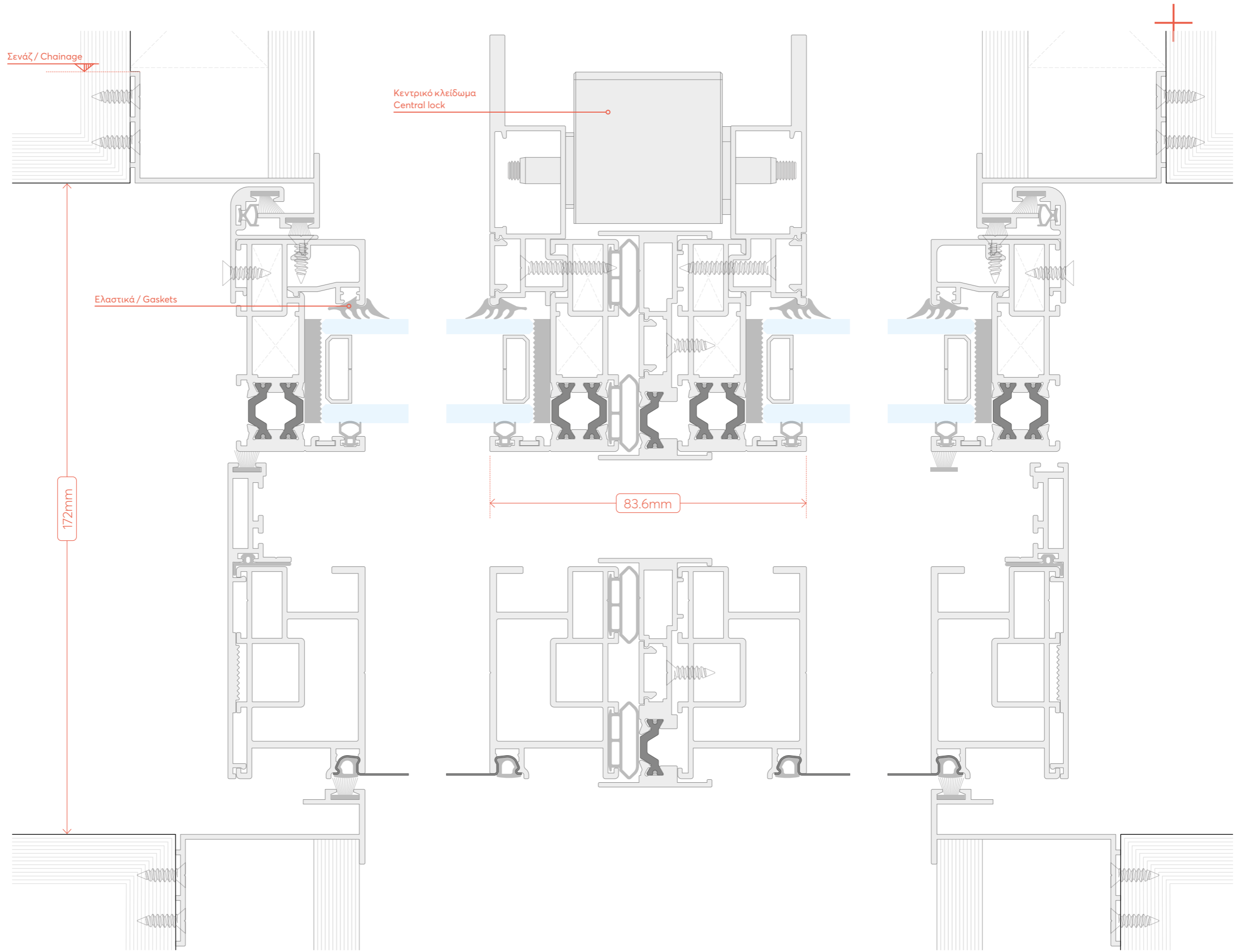

# SPACE Inside Out

SECTION

## 17.a



ΤΥΠΟΛΟΓΙΑ  
ΠΑΡΑΘΥΡΟ  
ΠΕΝΤΑΦΥΛΛΟ  
FIVE-SASH  
WINDOW

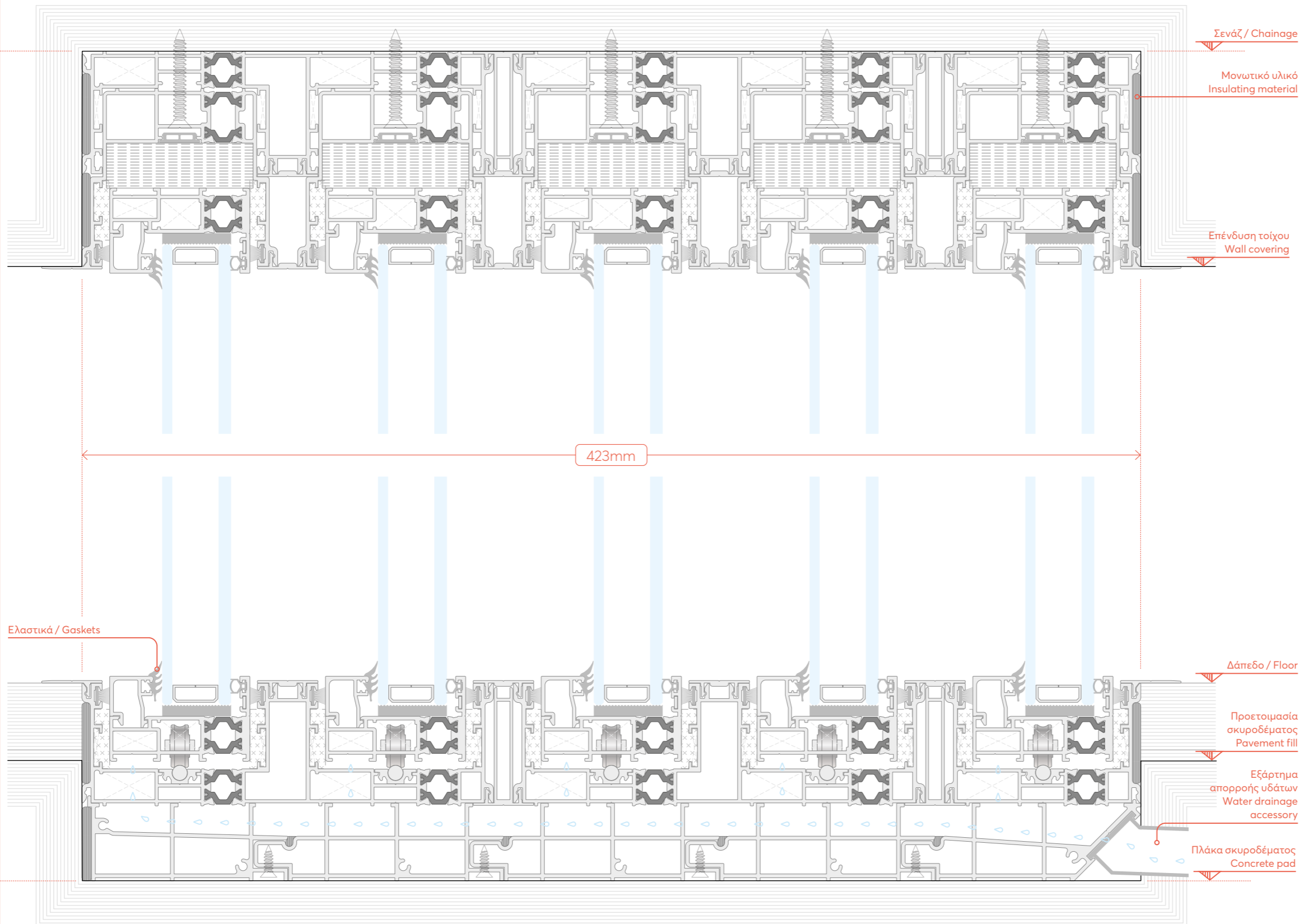

Σενάζι / Chainage

Μονωτικό υλικό  
Insulating material

Επένδυση τοίχου  
Wall covering

85.9mm

423mm

Ελαστικά / Gaskets

78.9mm

Δάπεδο / Floor

Προετοιμασία  
σκυροδέματος  
Pavement fill

Εξάρτημα  
απορροής υδάτων  
Water drainage  
accessory

Πλάκα σκυροδέματος  
Concrete pad

DESIGN SCALED TO FIT



# SPACE Inside Out

SECTION

## 17.b

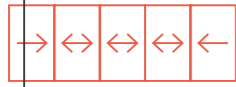

TYPOLOGY  
ΠΑΡΑΘΥΡΟ  
ΠΕΝΤΑΦΥΛΛΟ  
ΜΕ ΣΧΑΡΑ  
FIVE-SASH  
WINDOW WITH  
GRATE

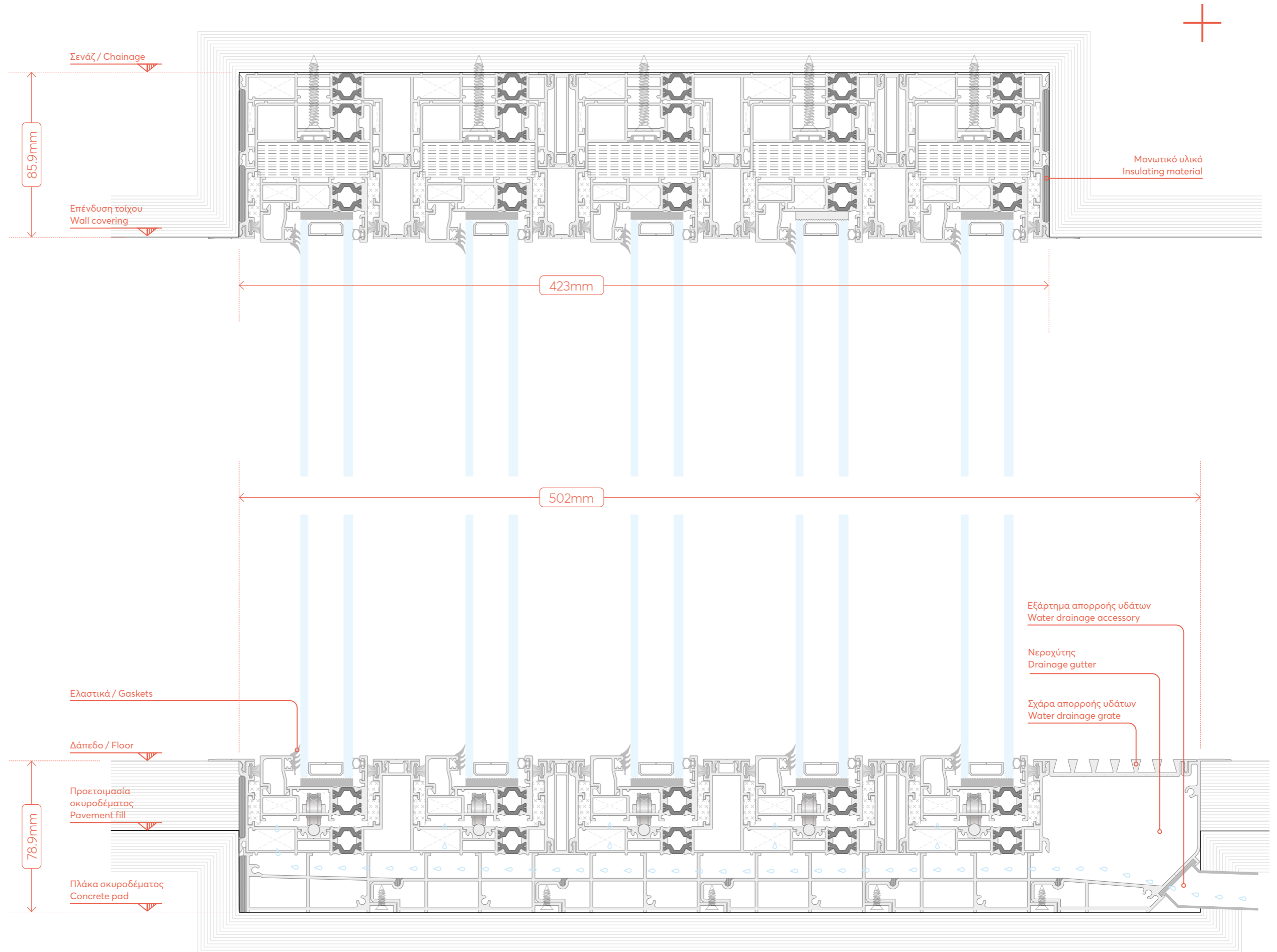



# SPACE Inside Out

SECTION

# 18.0

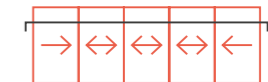

TYPOLGY  
ΠΑΡΑΘΥΡΟ  
ΠΕΝΤΑΦΥΛΛΟ  
FIVE-SASH  
WINDOW

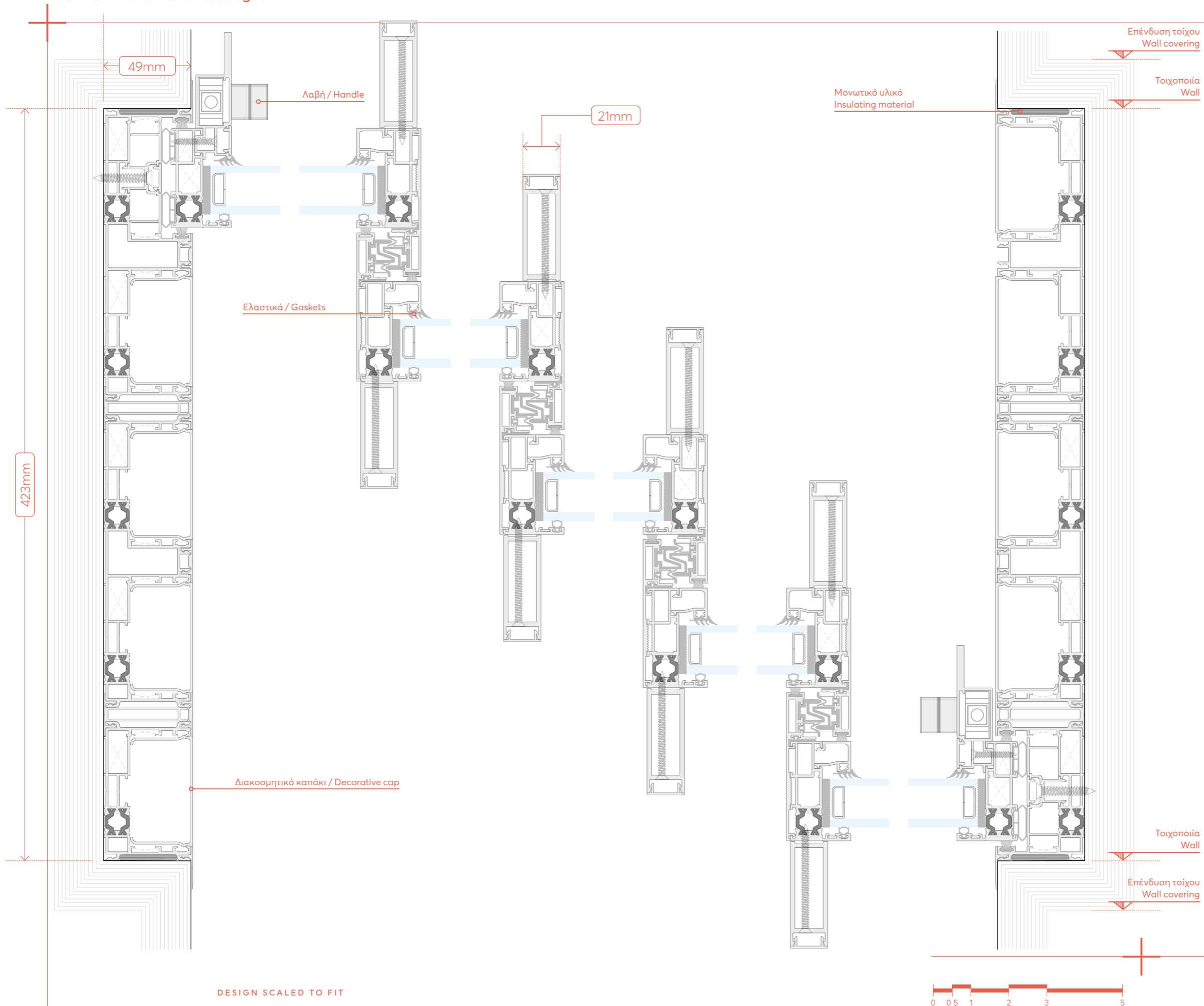

DESIGN SCALED TO FIT

# SPACE Inside Out

SECTION

# 19.0



TYPOLGY  
ΠΑΡΑΘΥΡΟ ΓΩΝΙΑΚΟ  
ΜΕ ΣΙΤΑ  
CORNER WINDOW  
WITH MOSQUITO NET

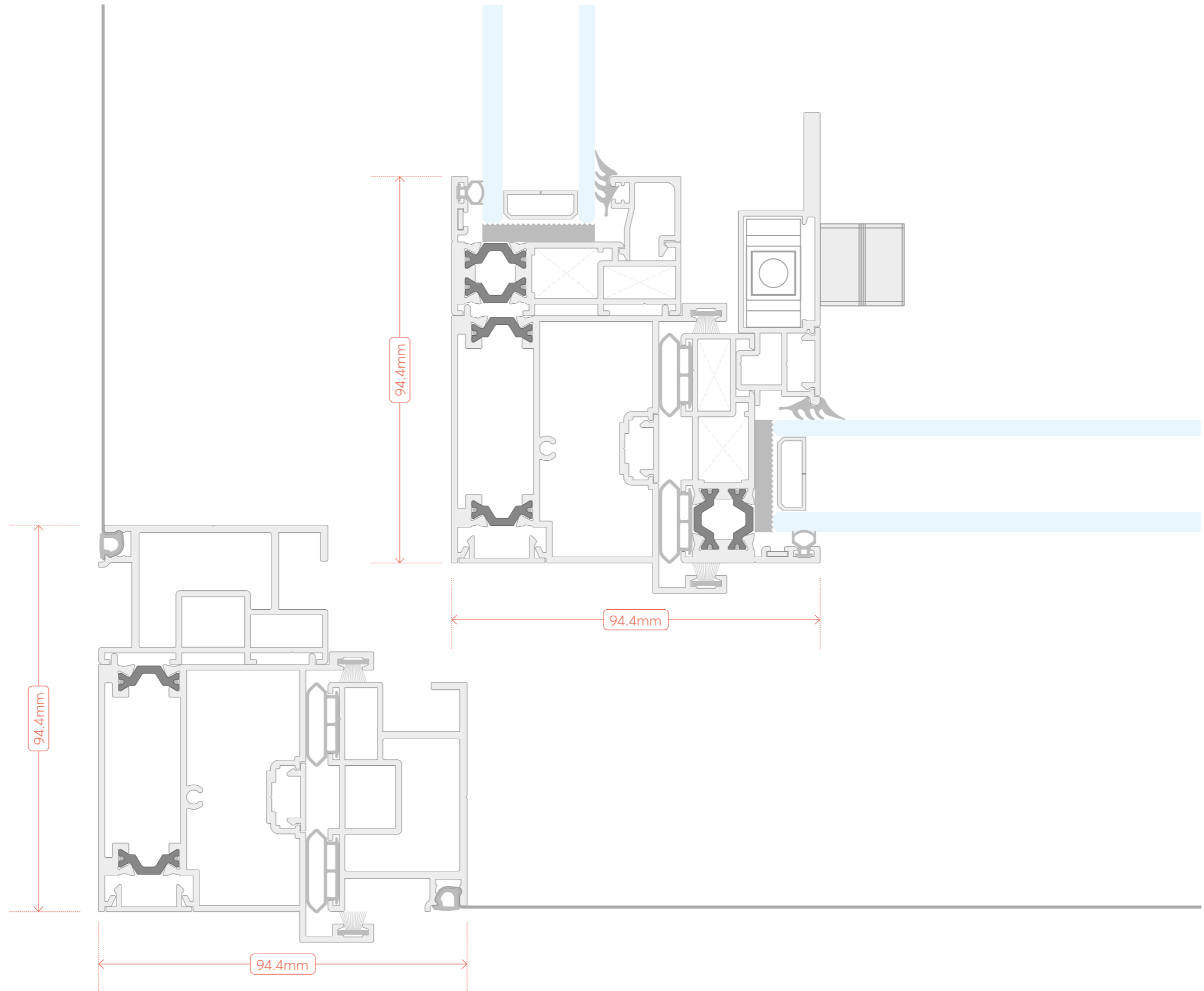

# SPACE Inside Out

TYPOLGY  
ΦΥΛΛΟ ΚΑΙ ΤΥΠΟΛΟΓΙΑ  
ΤΖΑΜΙΩΝ  
SASH AND GLASS  
TYPOLOGY

TECH INFO  
ΛΕΠΤΟΜΕΡΕΙΑ  
ΛΑΒΗΣ Α  
SPACE HANDLE A  
DETAIL

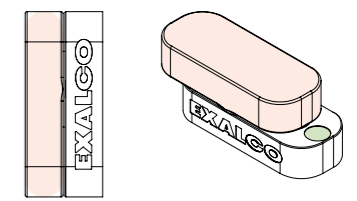

TECH INFO  
ΛΕΠΤΟΜΕΡΕΙΑ  
ΛΑΒΗΣ Β  
SPACE HANDLE B  
DETAIL

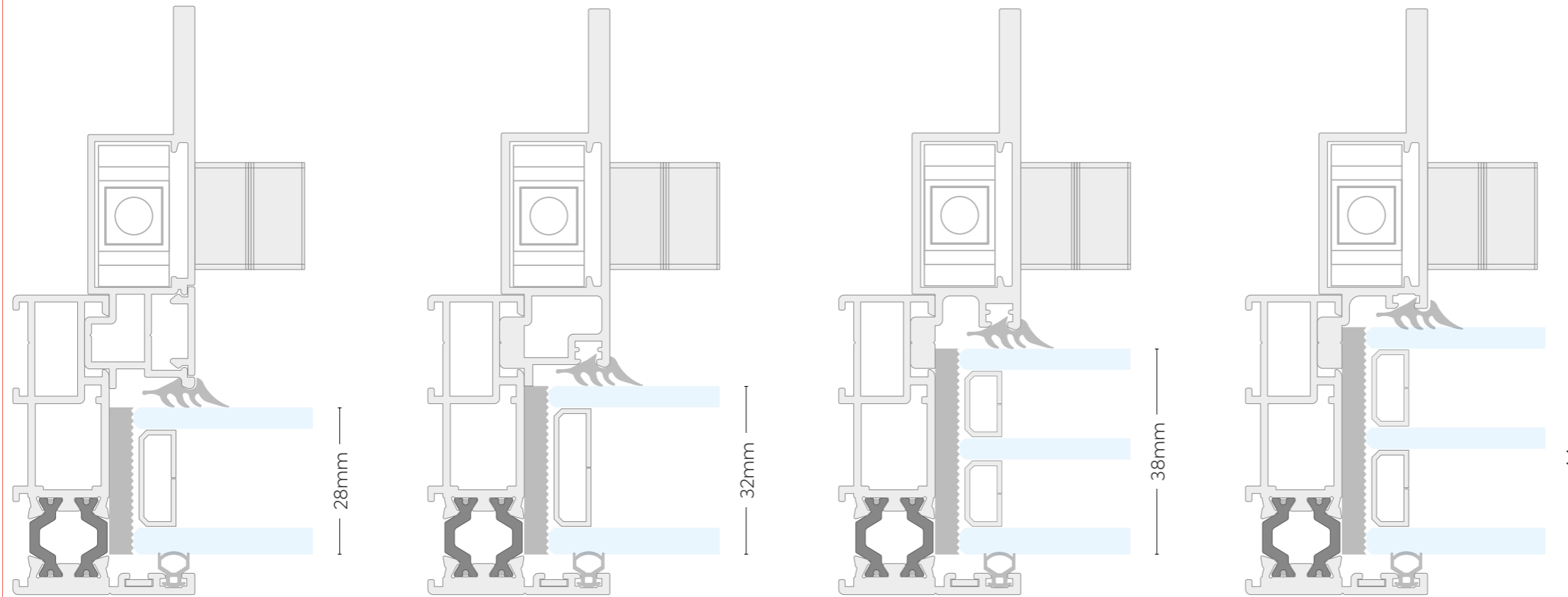
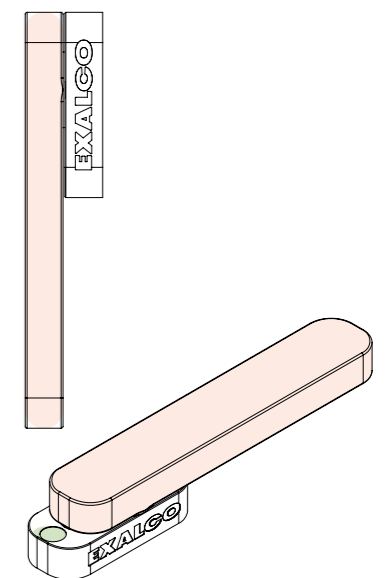

28mm                      32mm                      38mm                      44mm

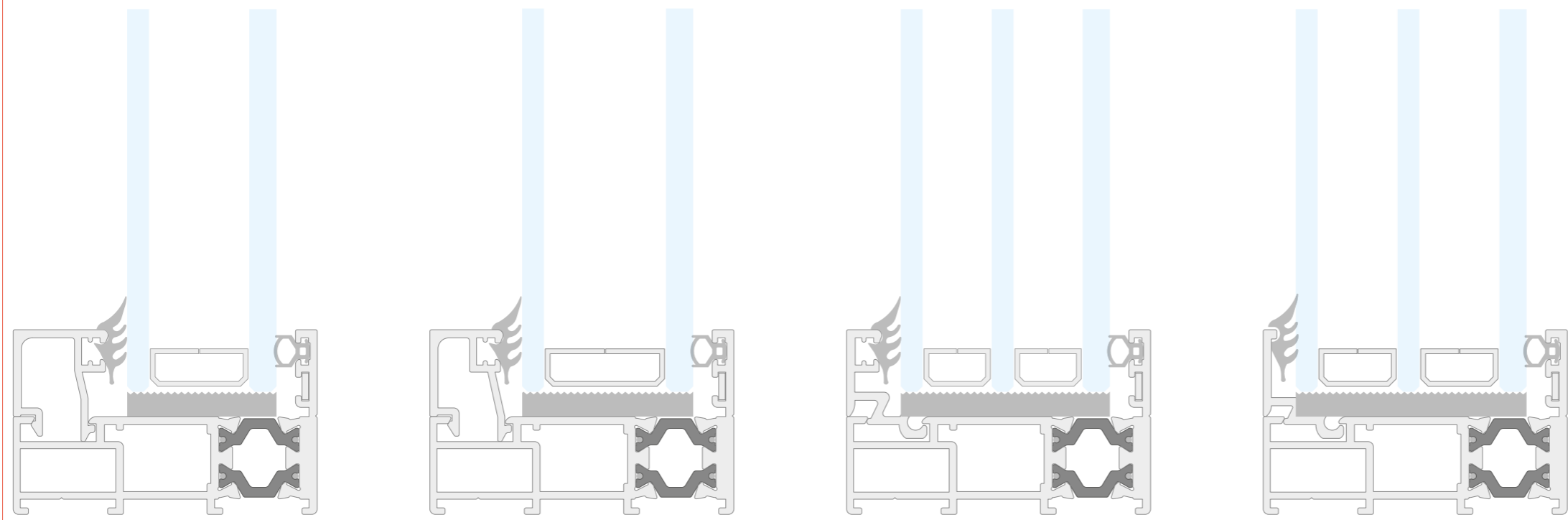

DESIGN SCALE 1:1





# SPACE

## SPACE INVISIBLE

Ο θαμμένος οδηγός, ορατός μόνο σαν δύο γραμμές δίνει τη δυνατότητα της συνέχειας του δαπέδου απο μέσα προς τα έξω.

The buried guide, only visible as two lines, provides the possibility of floor extension from the inside out.

# SPACE Invisible

SECTION

# 1.0

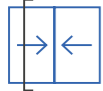

TYPOLGY  
ΠΑΡΑΘΥΡΟ ΔΙΦΥΛΛΟ  
ΕΠΑΛΛΗΛΟ  
DOUBLE-SASH  
WINDOW

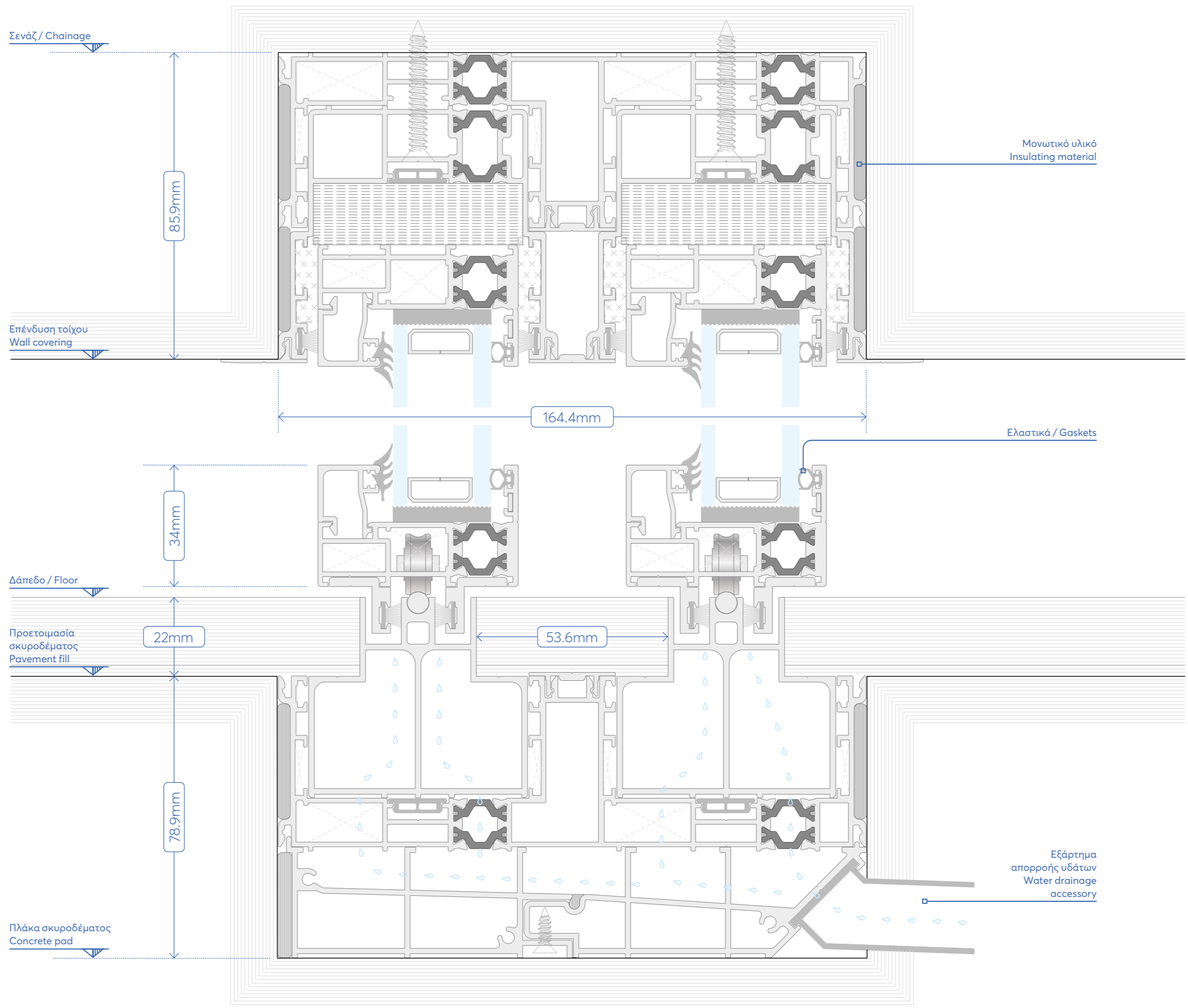

# SPACE Invisible

SECTION

## 2.0

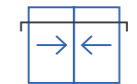

TYPOLGY  
ΠΑΡΑΘΥΡΟ ΔΙΦΥΛΛΟ  
ΕΠΑΛΛΗΛΟ  
DOUBLE-SASH WINDOW

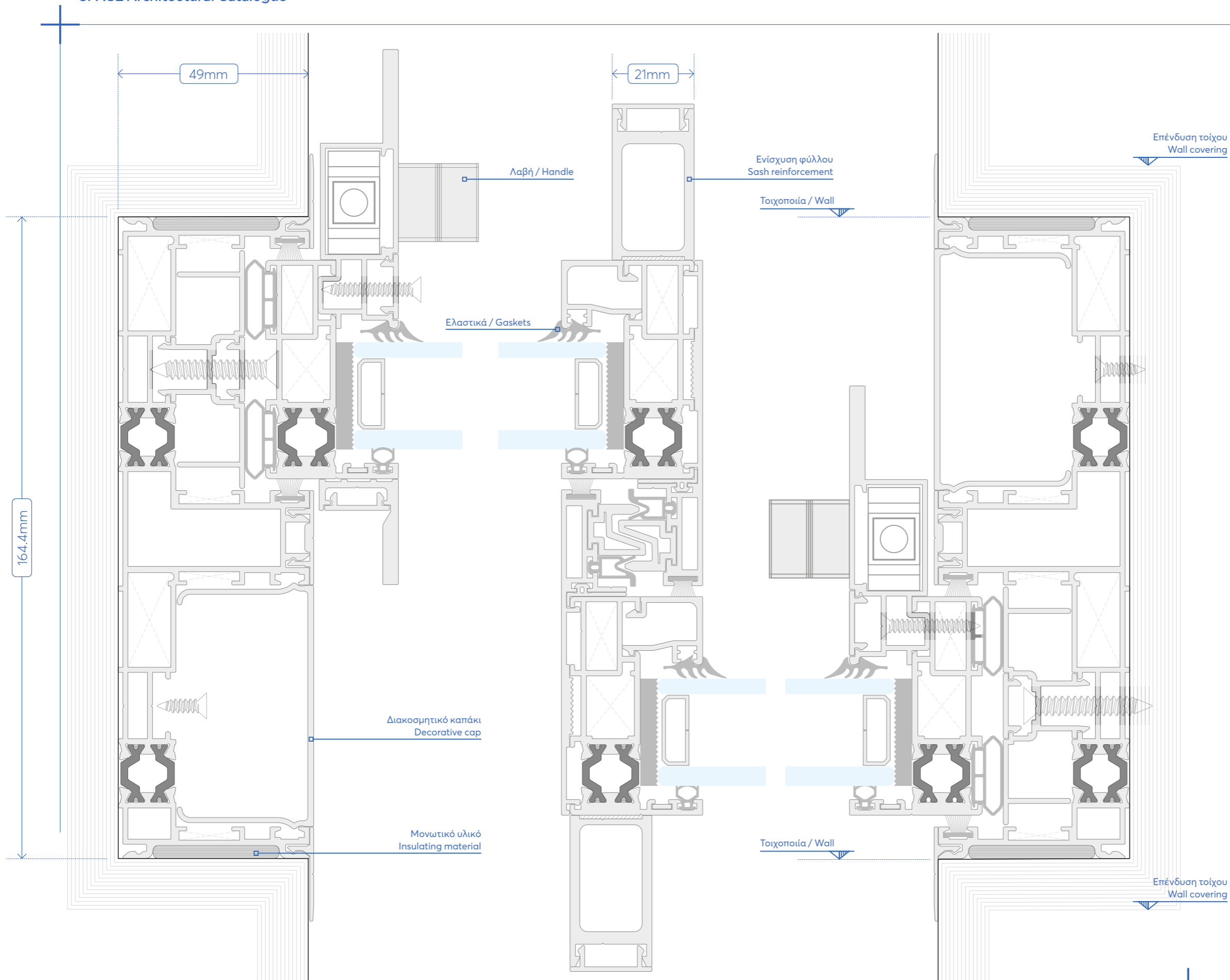

DESIGN SCALE 1:1

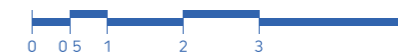

# SPACE Invisible

SECTION

## 3.0

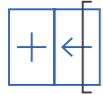

TYPOLGY  
ΠΑΡΑΘΥΡΟ ΔΙΦΥΛΛΟ  
ΜΕ ΕΝΑ ΦΥΛΛΟ ΣΤΑΘΕΡΟ  
DOUBLE-SASH WINDOW  
WITH ONE SASH FIXED

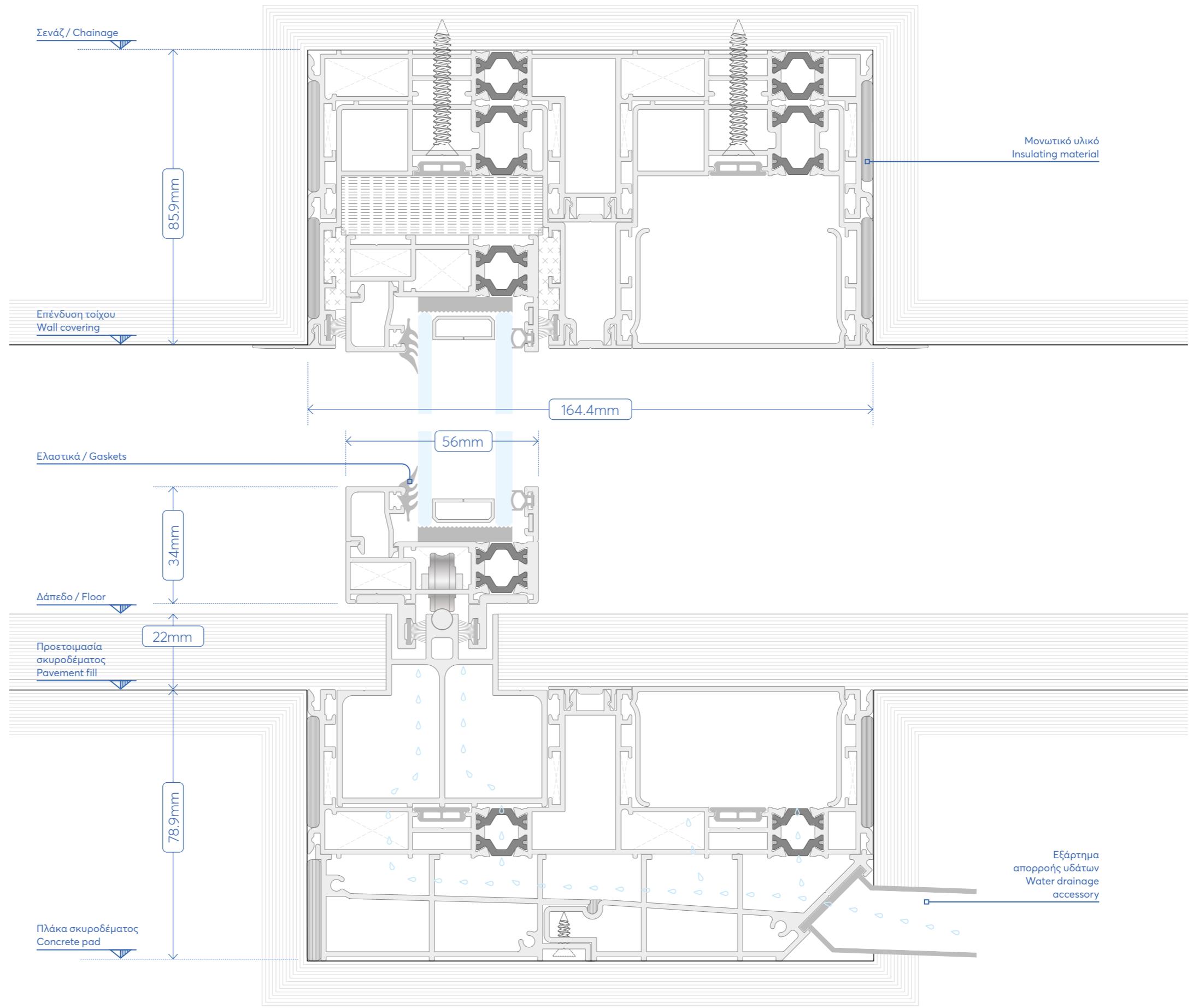



# SPACE Invisible

SECTION

## 4.0

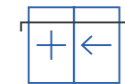

TYPOLGY  
ΠΑΡΑΘΥΡΟ ΔΙΦΥΛΛΟ ΜΕ  
ΕΝΑ ΦΥΛΛΟ ΣΤΑΘΕΡΟ  
DOUBLE-SASH WINDOW  
WITH ONE FIXED SASH

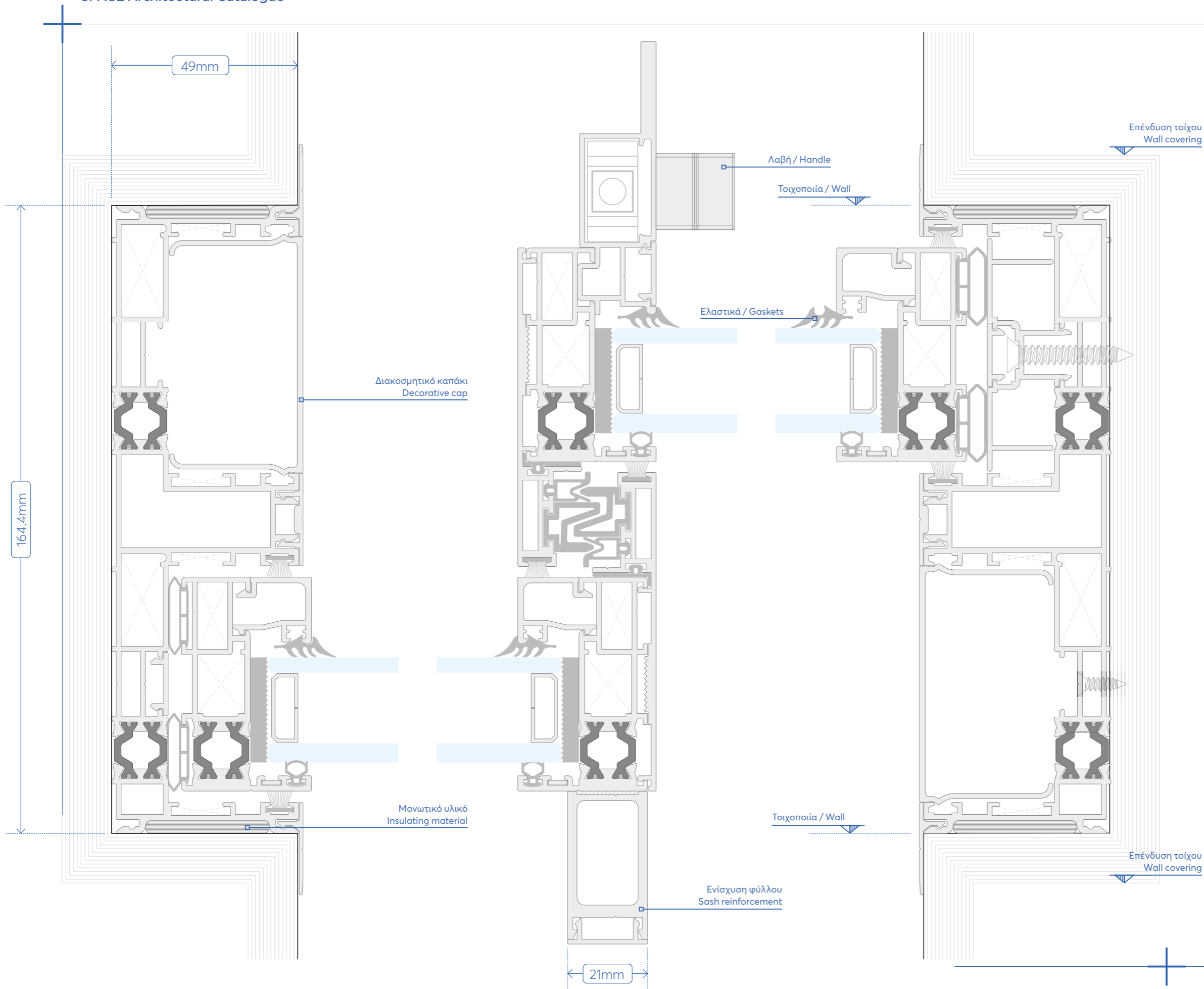

DESIGN SCALE 1:1



INVISIBLE

# SPACE Invisible

SECTION

## 5.0

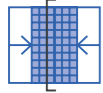

TYPOLOGY  
ΠΑΡΑΘΥΡΟ ΔΙΦΥΛΛΟ  
ΕΠΑΛΛΗΛΟ ΜΕ ΣΙΤΑ  
DOUBLE-SASH WINDOW  
WITH MOSQUITO NET

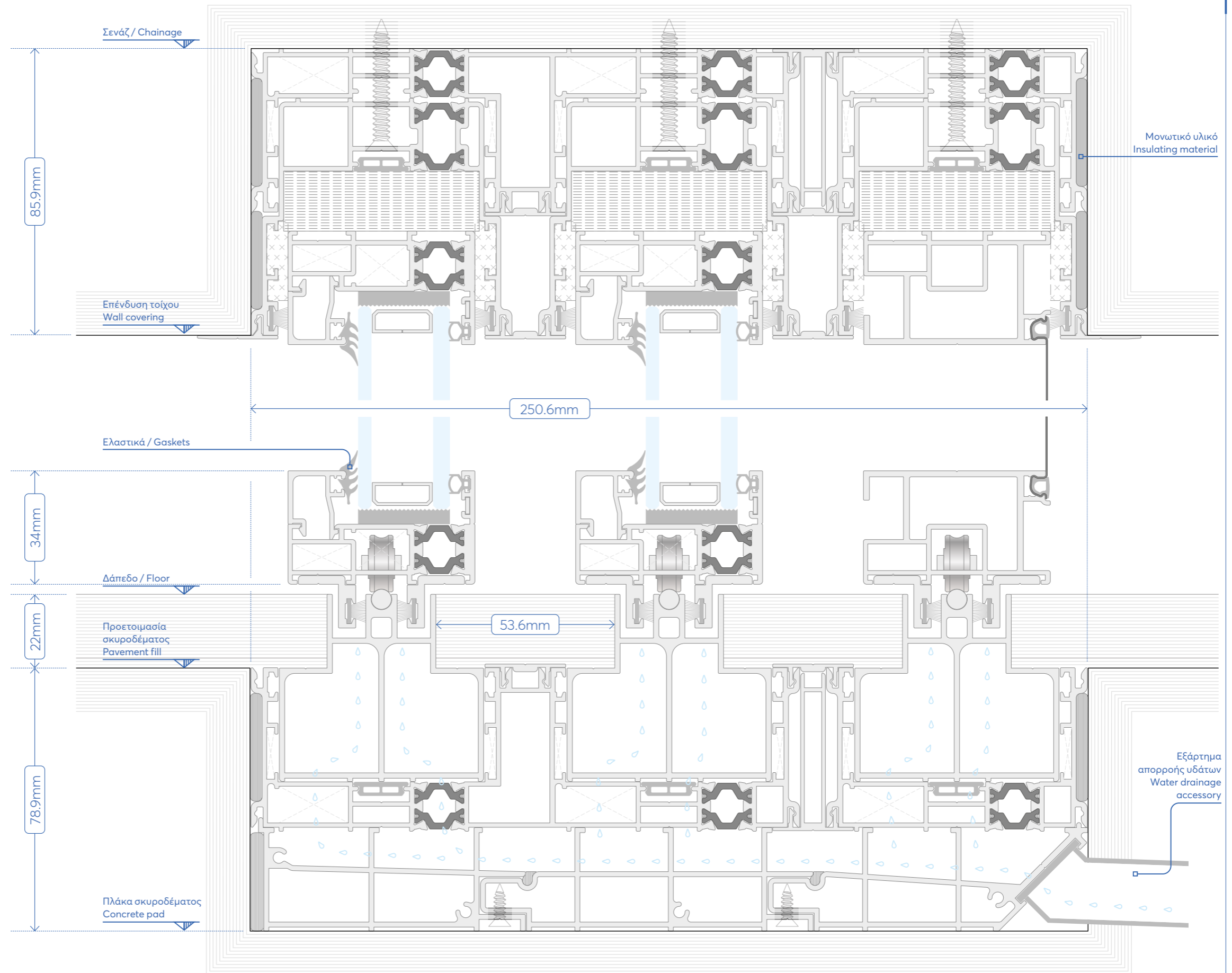

# SPACE Invisible

SECTION

## 6.0

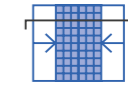

TYPOLGY  
ΠΑΡΑΘΥΡΟ ΔΙΦΥΛΛΟ  
ΕΠΑΛΛΗΛΟ ΜΕ ΣΙΤΑ  
DOUBLE-SASH WINDOW  
WITH MOSQUITO NET

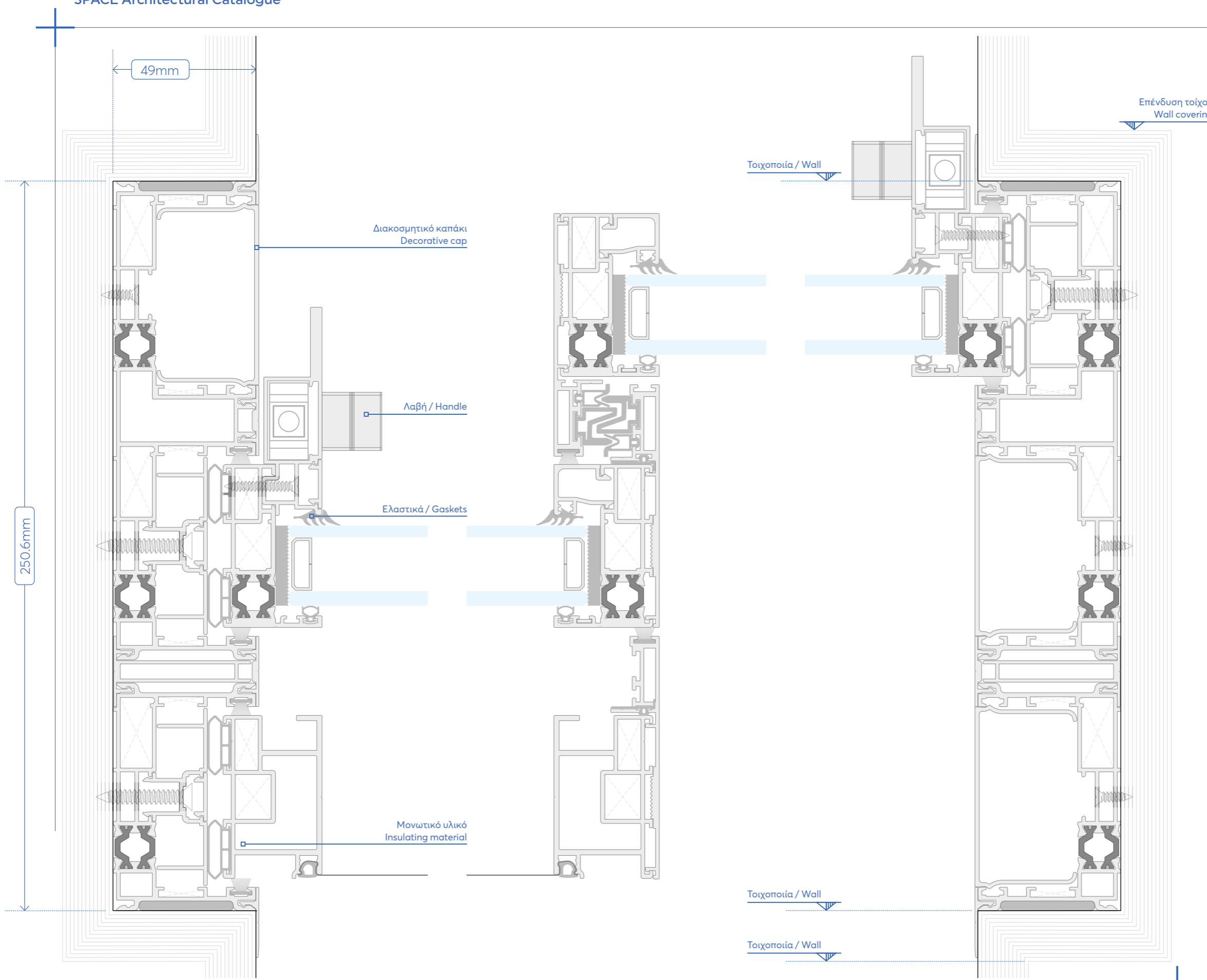

DESIGN SCALED TO FIT



INVISIBLE

# SPACE Invisible

SECTION

## 7.0

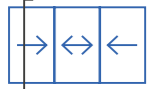

TYPOLGY  
ΠΑΡΑΥΡΟ ΤΡΙΦΥΛΛΟ  
TRIPLE-SASH WINDOW

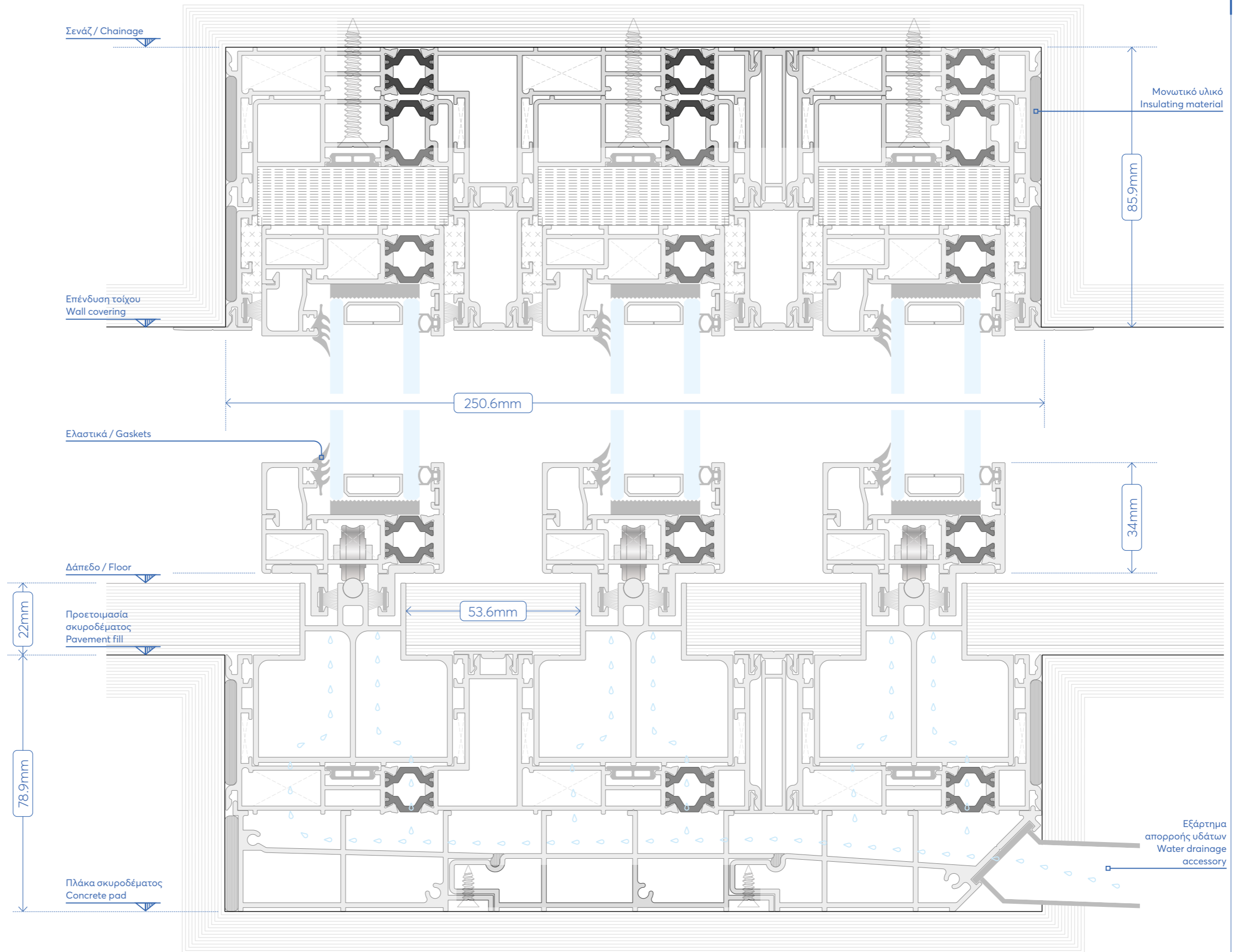

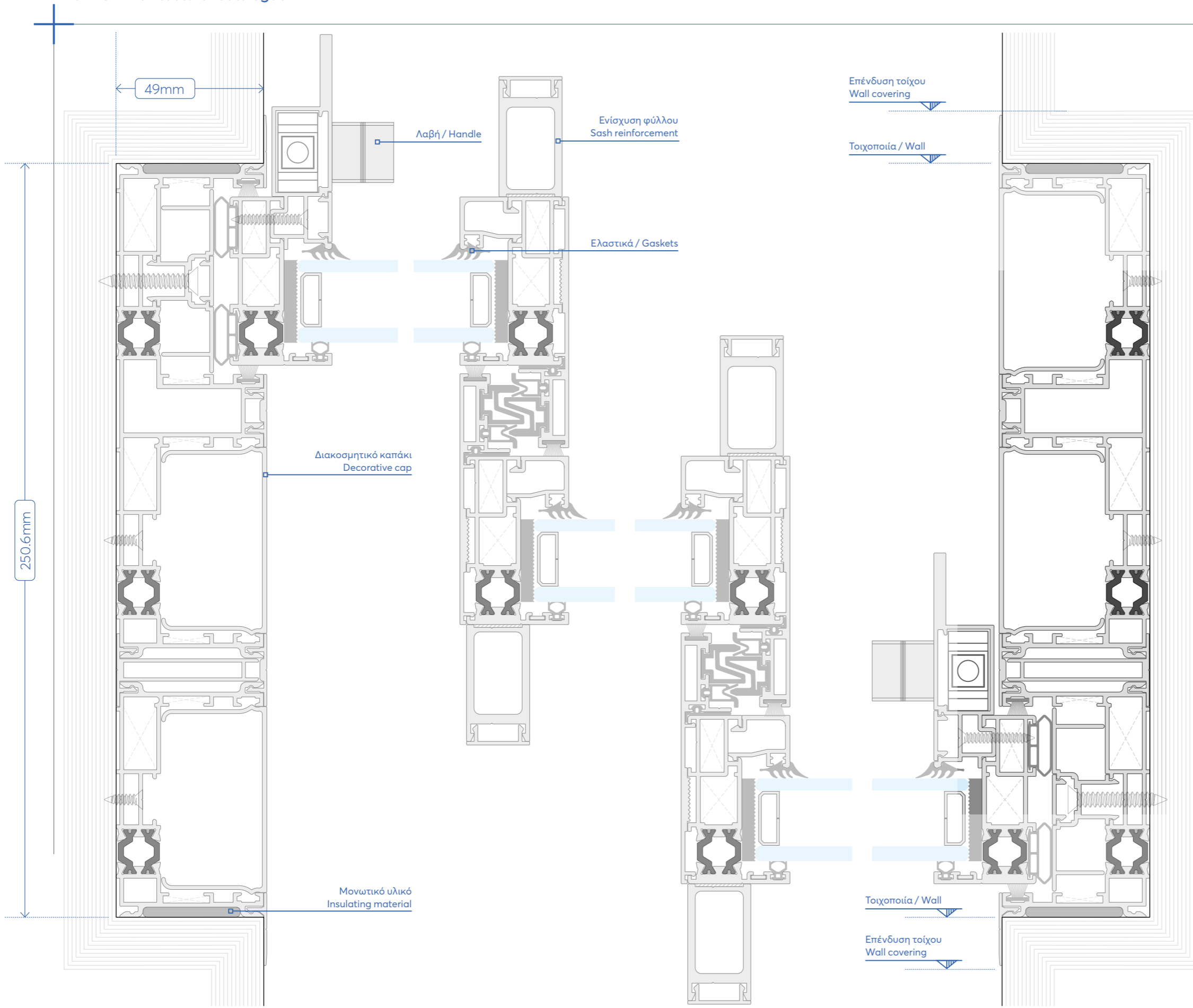

# SPACE Invisible

SECTION

## 8.0

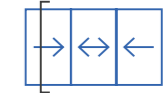

TYPOLGY  
ΠΑΡΑΘΥΡΟ ΤΡΙΦΥΛΛΟ  
TRIPLE-SASH WINDOW

# SPACE Invisible

SECTION

## 9.0

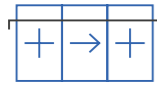

**TYPOLGY**  
ΠΑΡΑΘΥΡΟ ΤΡΙΦΥΛΛΟ  
ΜΕ ΕΝΑ ΚΙΝΗΤΟ ΦΥΛΛΟ  
TRIPLE-SASH WINDOW  
ON DOUBLE RAIL WITH  
ONE MOVING SASH

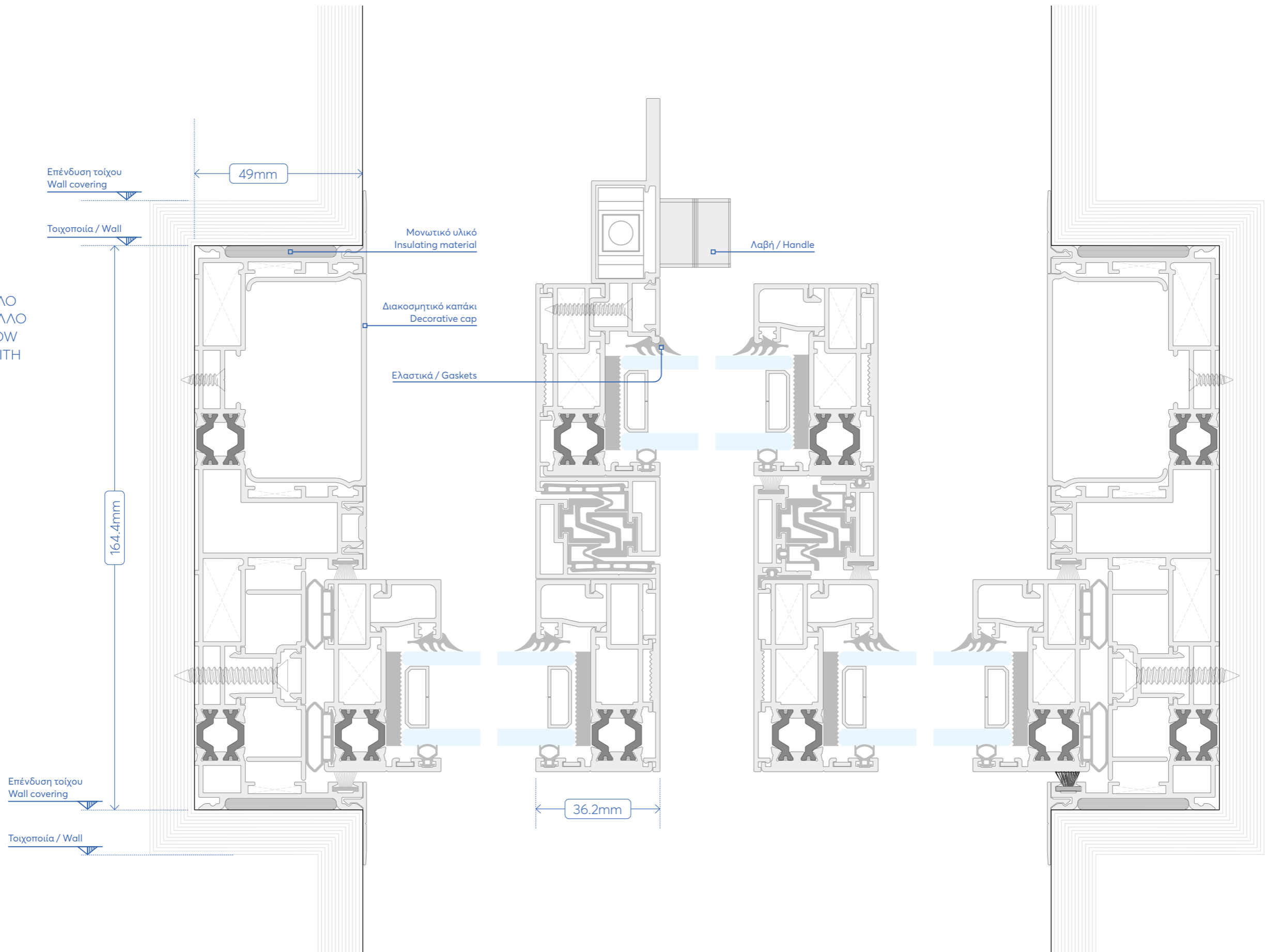

# SPACE Invisible

SECTION

## 10.0



TYPOLGY  
ΠΑΡΑΘΥΡΟ  
ΜΟΝΟΦΥΛΛΟ  
ΧΩΝΕΥΤΟ  
SINGLE-SASH  
RECESSED WINDOW

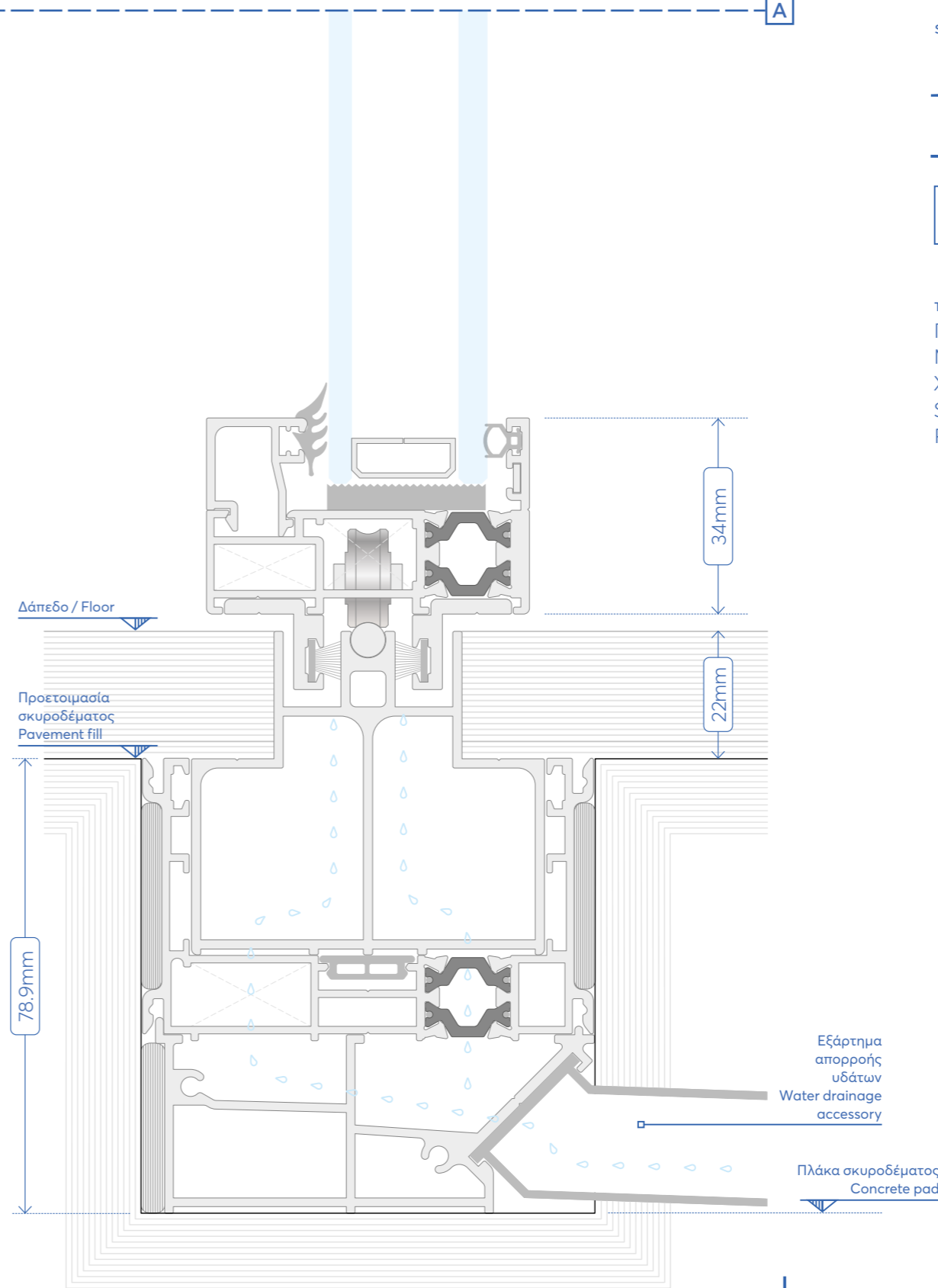
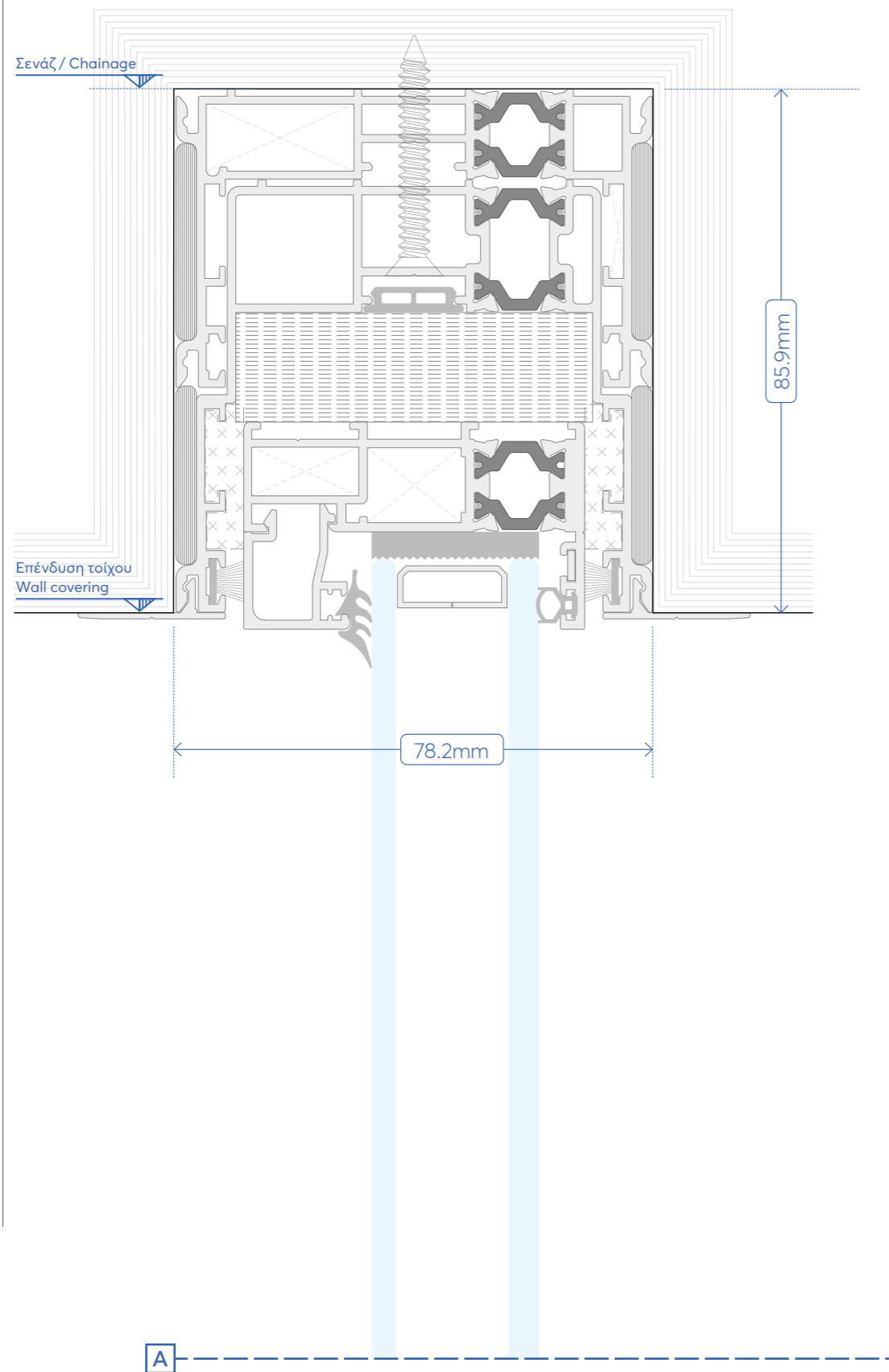

# SPACE Invisible

SECTION

## 11.0



TYPOLOGY  
ΠΑΡΑΘΥΡΟ  
ΜΟΝΟΦΥΛΛΟ ΧΩΝΕΥΤΟ  
SINGLE-SASH RECESSED  
WINDOW

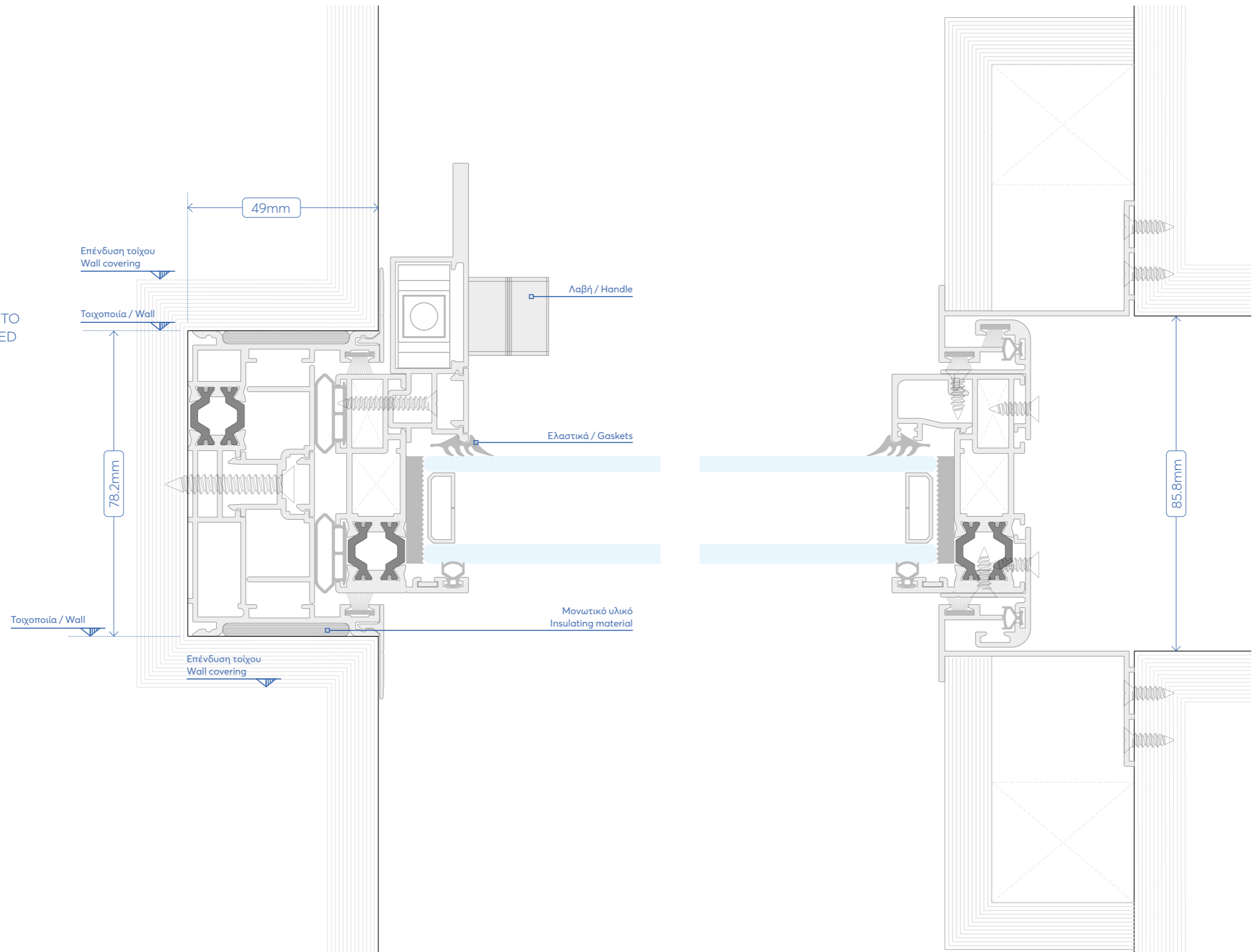



# SPACE Invisible

SECTION

## 12.0

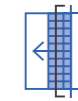

TYPOLGY  
ΠΑΡΑΘΥΡΟ  
ΜΟΝΟΦΥΛΛΟ  
ΧΩΝΕΥΤΟ ΜΕ ΣΙΤΑ  
SINGLE-SASH  
RECESSED WINDOW  
WITH MOSQUITO NET

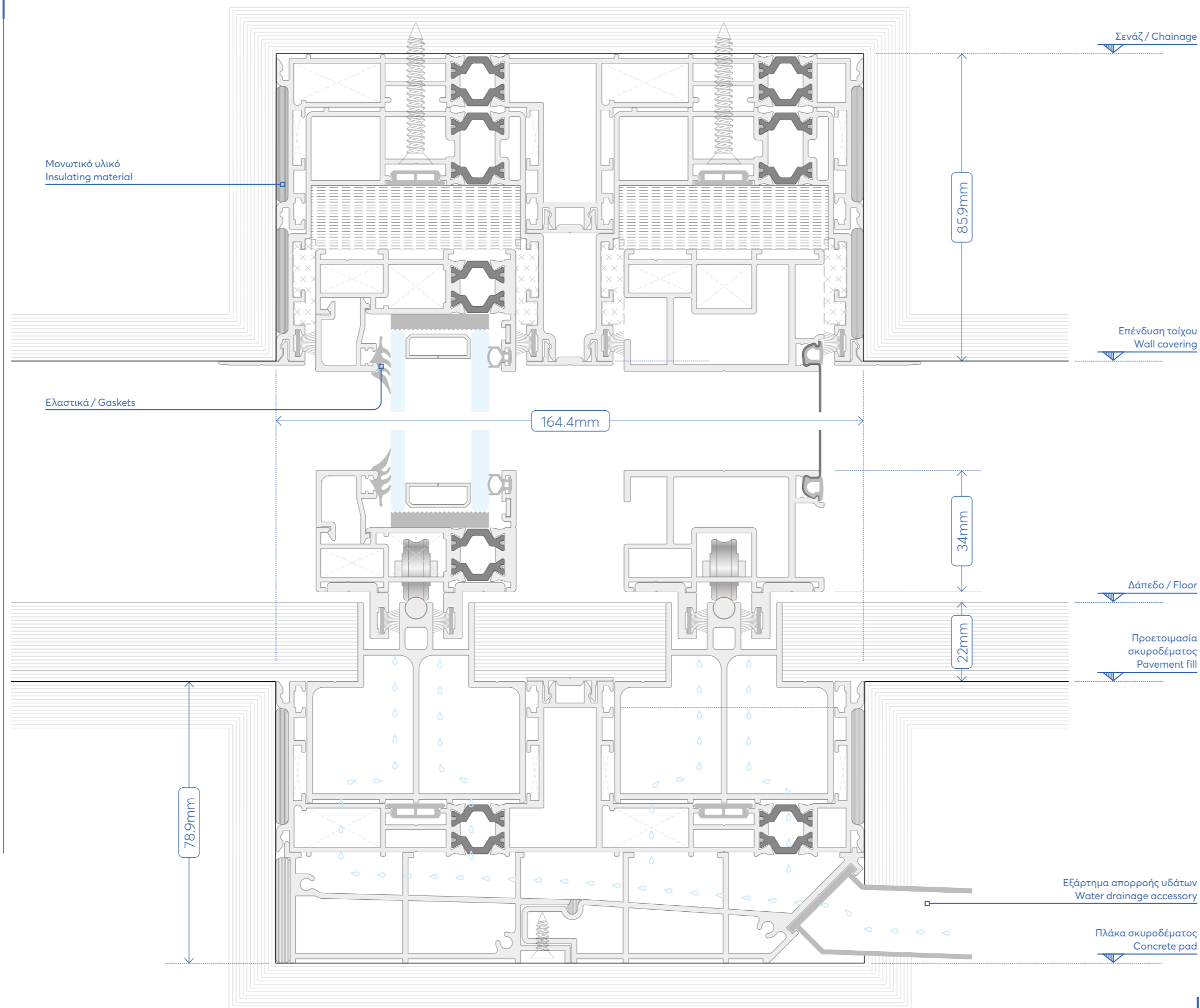

DESIGN SCALED TO FIT



# SPACE Invisible

SECTION

# 13.0



TYPOLGY  
ΠΑΡΑΘΥΡΟ  
ΜΟΝΟΦΥΛΛΟ ΧΩΝΕΥΤΟ  
ΜΕ ΣΙΤΑ  
SINGLE-SASH RECESSED  
WINDOW WITH  
MOSQUITO NET

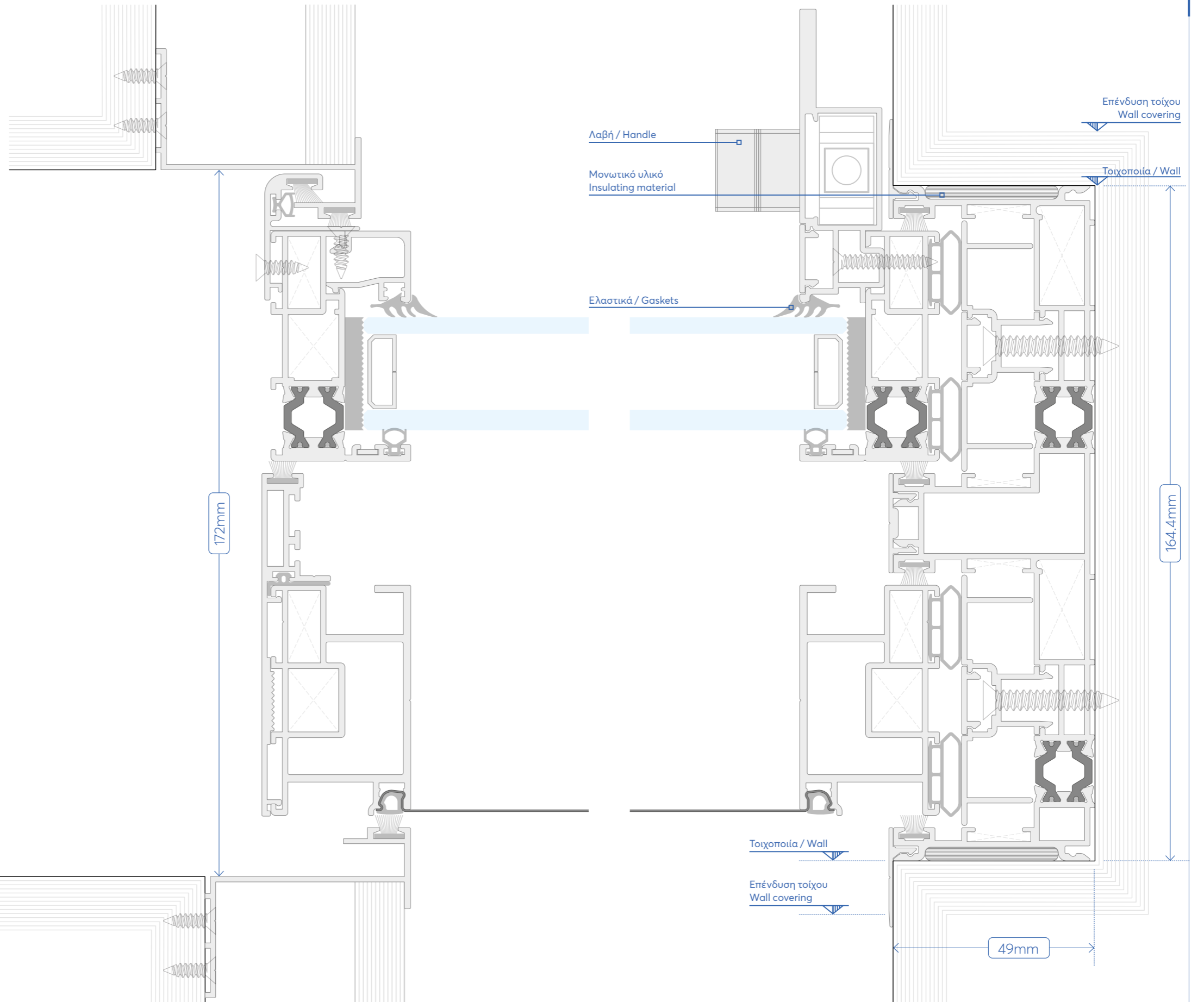

# SPACE Invisible

SECTION

## 14.0

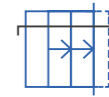

TYPOLGY  
ΠΑΡΑΘΥΡΟ ΔΙΦΥΛΛΟ  
ΧΩΝΕΥΤΟ  
ΠΑΡΑΣΥΡΟΜΕΝΟ  
DOUBLE-SASH  
RECESSED WINDOW

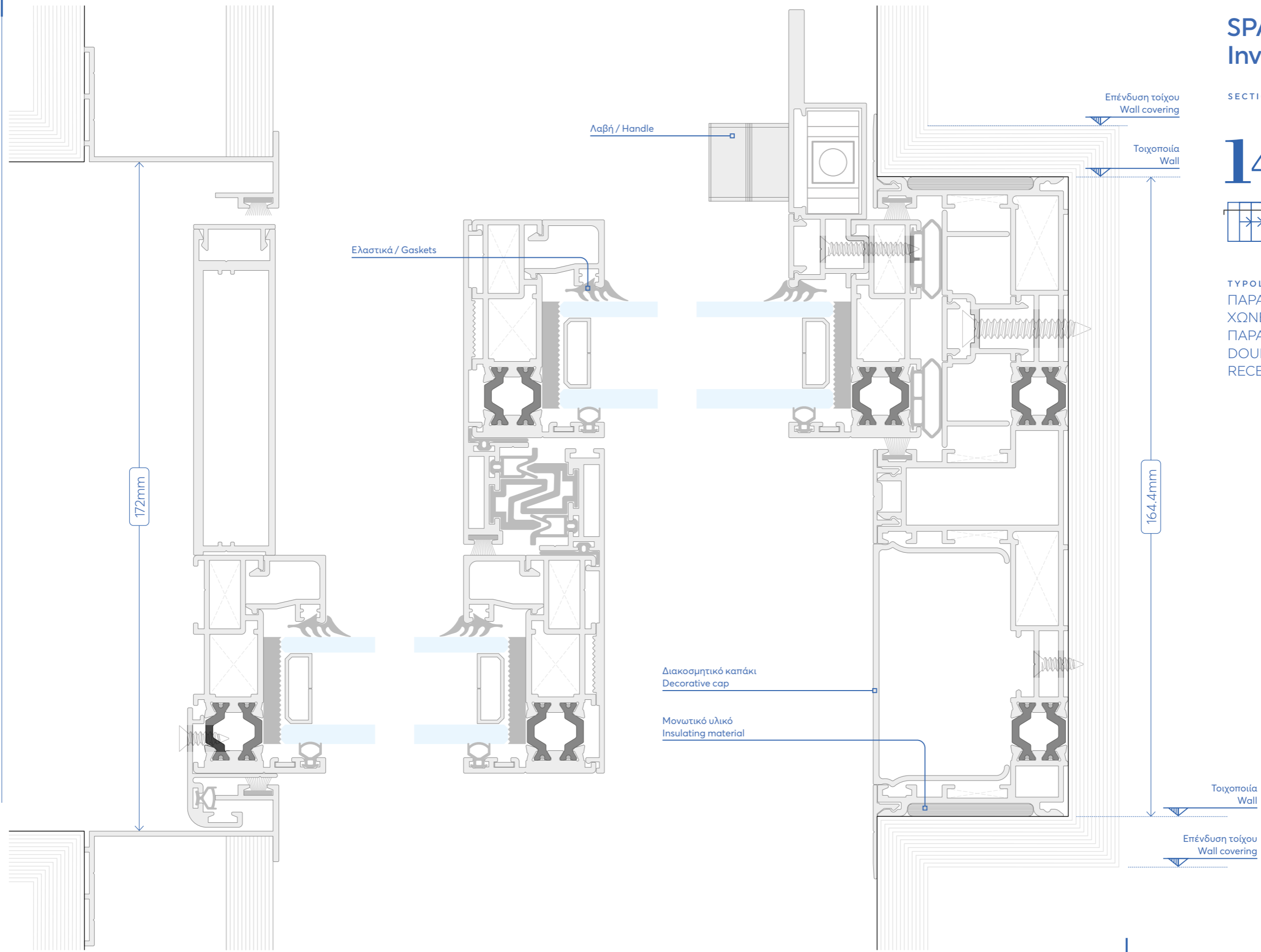

Ελαστικά / Gaskets

Λαβή / Handle

Διακοσμητικό καπάκι  
Decorative cap

Μονωτικό υλικό  
Insulating material

Επένδυση τοίχου  
Wall covering

Τοιχοποιία  
Wall

Τοιχοποιία  
Wall

Επένδυση τοίχου  
Wall covering

172mm

164.4mm

DESIGN SCALE 1:1

0 0.5 1 2 3 5

# SPACE Invisible

SECTION

# 15.0

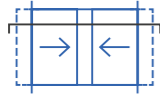

TYPOLGY  
ΠΑΡΑΘΥΡΟ ΔΙΦΥΛΛΟ  
ΦΙΛΗΤΟ ΧΩΝΕΥΤΟ  
DOUBLE-SASH RECESSED  
WINDOW WITH CENTRAL  
LOCK

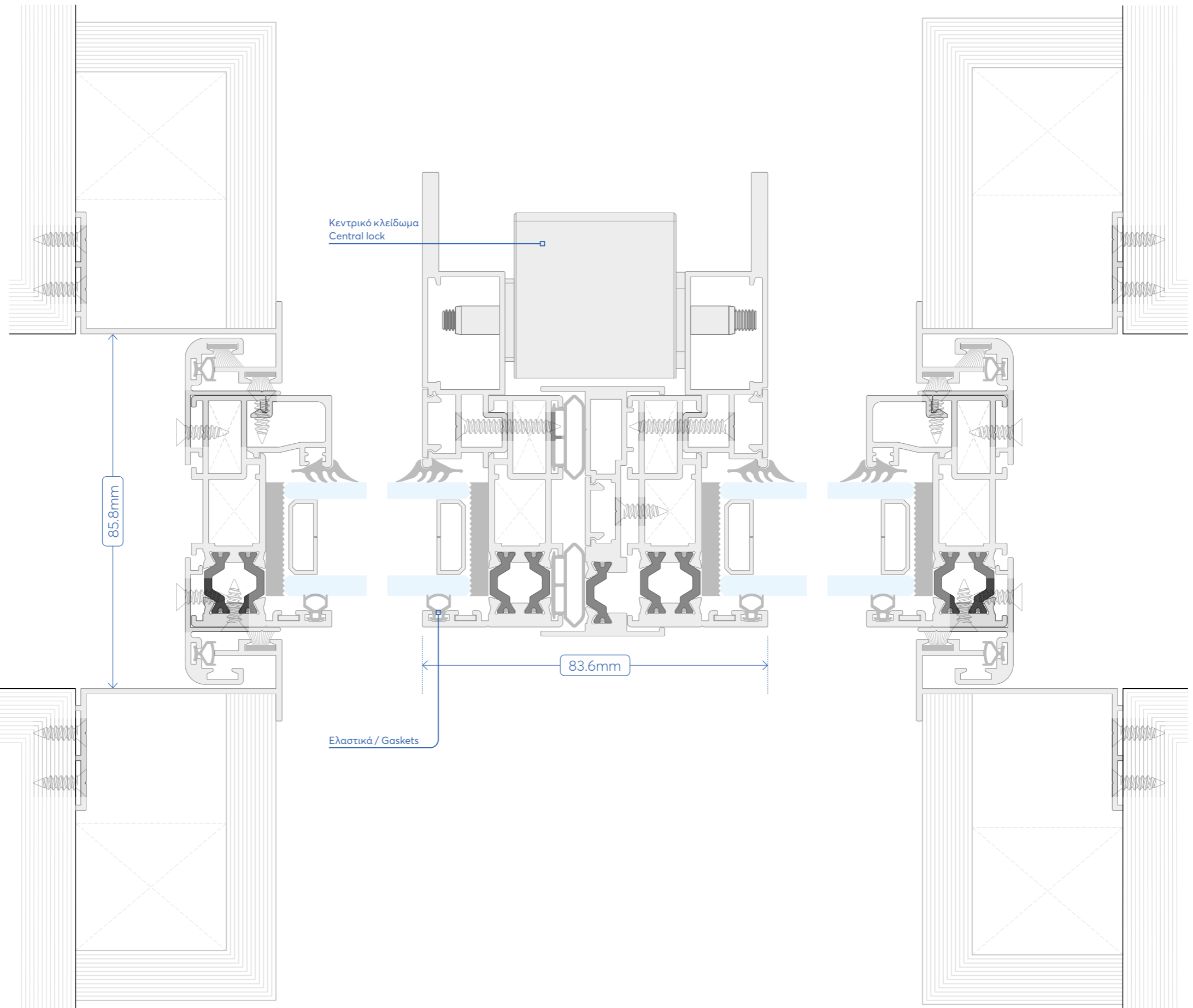

# SPACE Invisible

SECTION

## 16.0

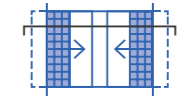

ΤΥΠΟΛΟΓΙΑ  
ΠΑΡΑΘΥΡΟ ΔΙΦΥΛΛΟ  
ΦΙΛΗΤΟ ΧΩΝΕΥΤΟ  
ΜΕ ΣΙΤΑ  
DOUBLE-SASH  
RECESSED WINDOW  
WITH MOSQUITO NET  
WITH CENTRAL LOCK

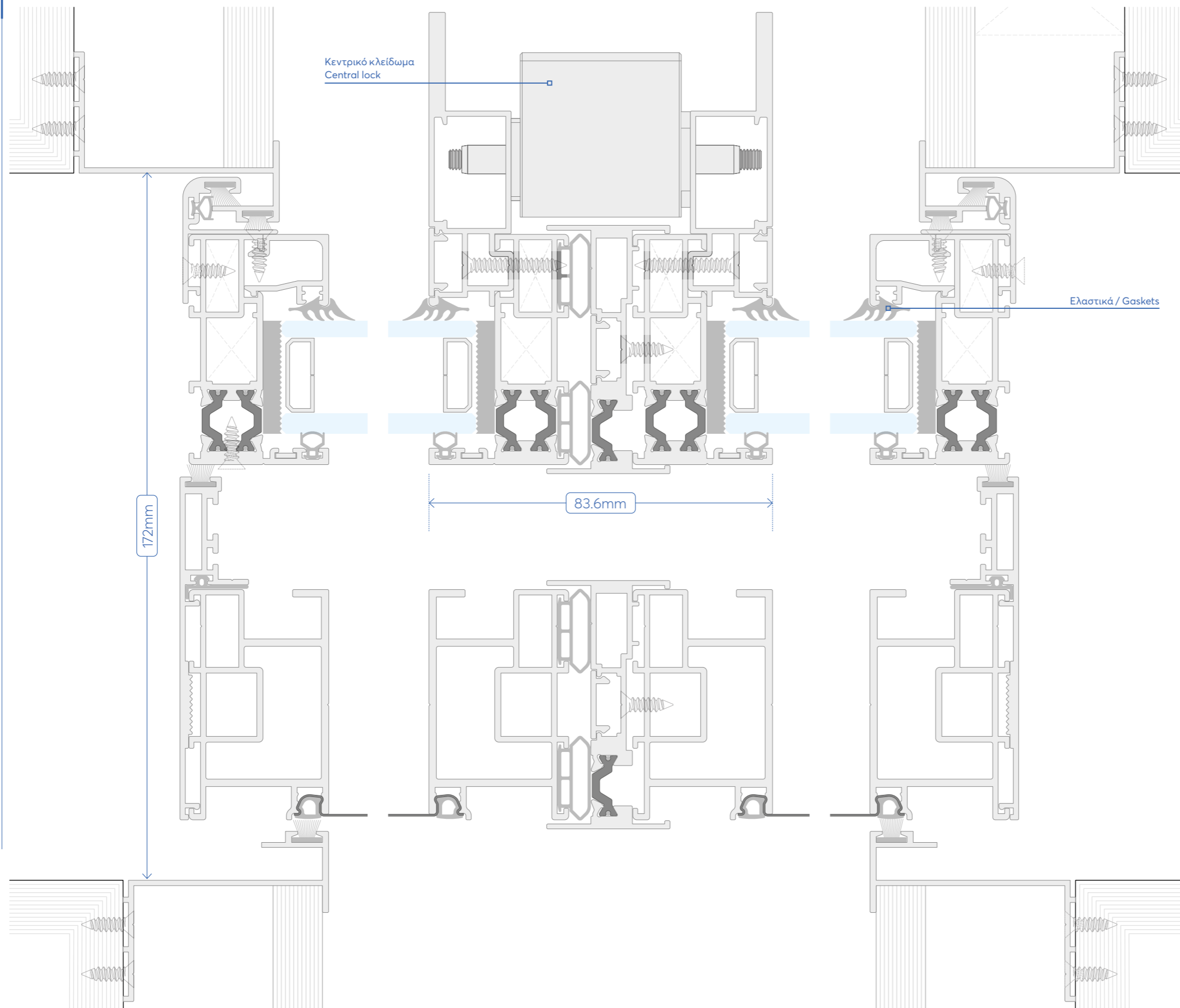

DESIGN SCALE 1:1



# SPACE Invisible

SECTION

# 17.0

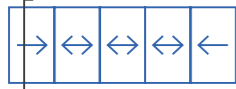

TYPOLGY  
ΠΕΝΤΑΦΥΛΛΟ  
ΠΑΡΑΘΥΡΟ  
FIVE-SASH WINDOW

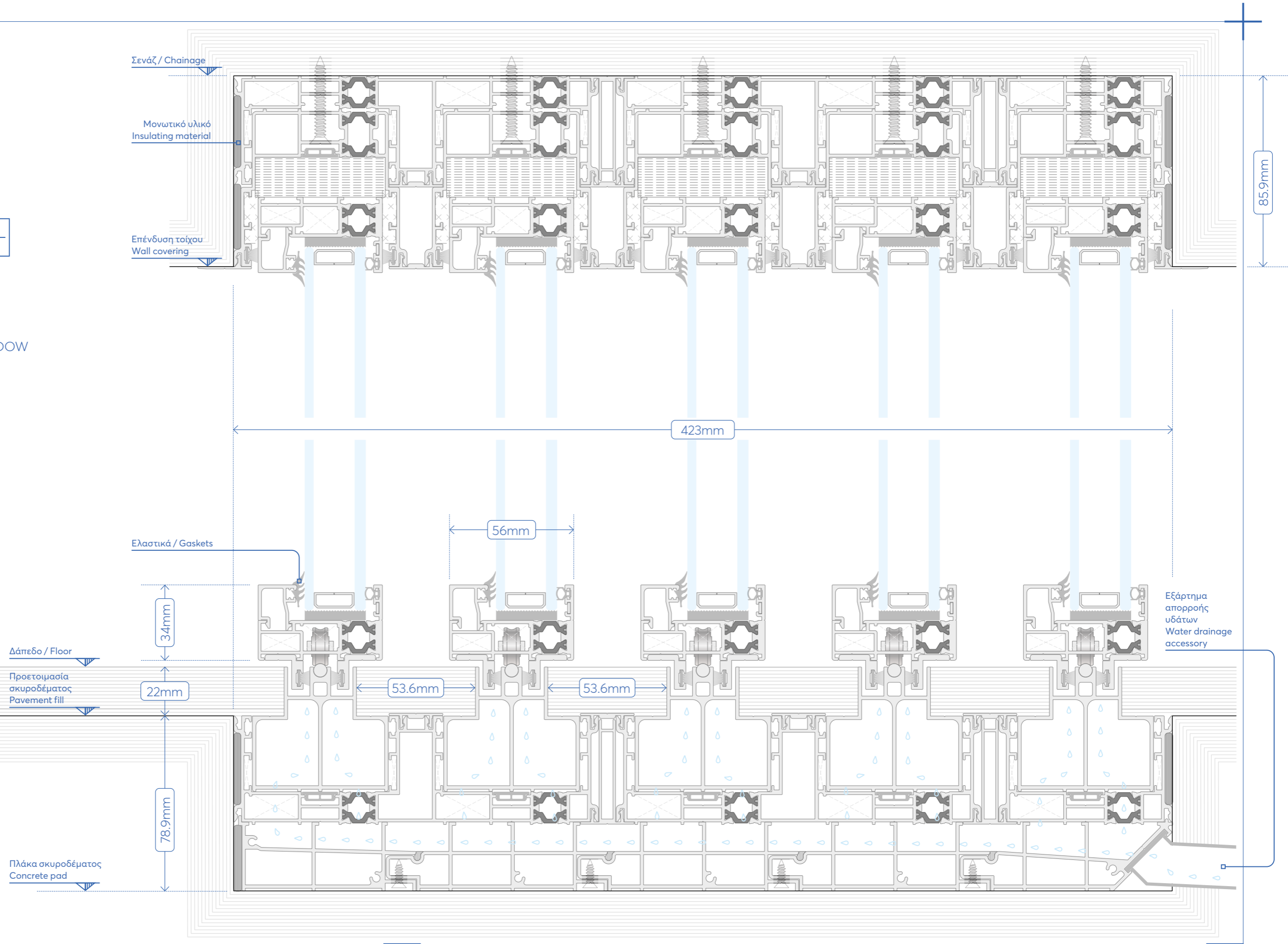

# SPACE Invisible

SECTION

# 18.0



TPOLOGY  
ΠΑΡΑΘΥΡΟ  
ΠΕΝΤΑΦΥΛΛΟ  
FIVE-SASH  
WINDOW

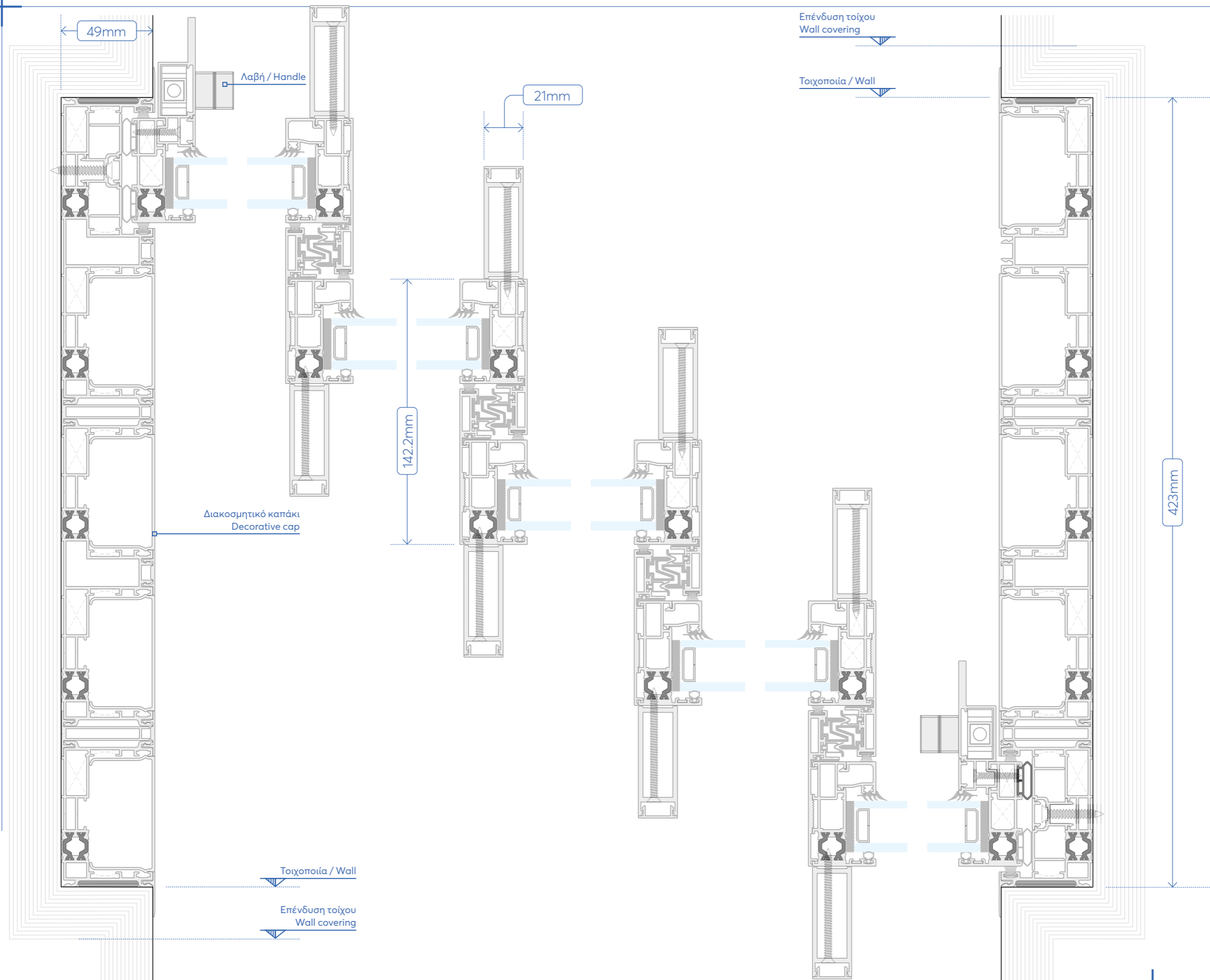

DESIGN SCALED TO FIT

# SPACE Invisible

SECTION

## 19.0

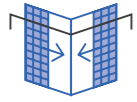

TYPOLGY  
ΠΑΡΑΘΥΡΟ ΓΩΝΙΑΚΟ  
ΜΕ ΣΙΤΑ  
CORNER WINDOW  
WITH MOSQUITO NET

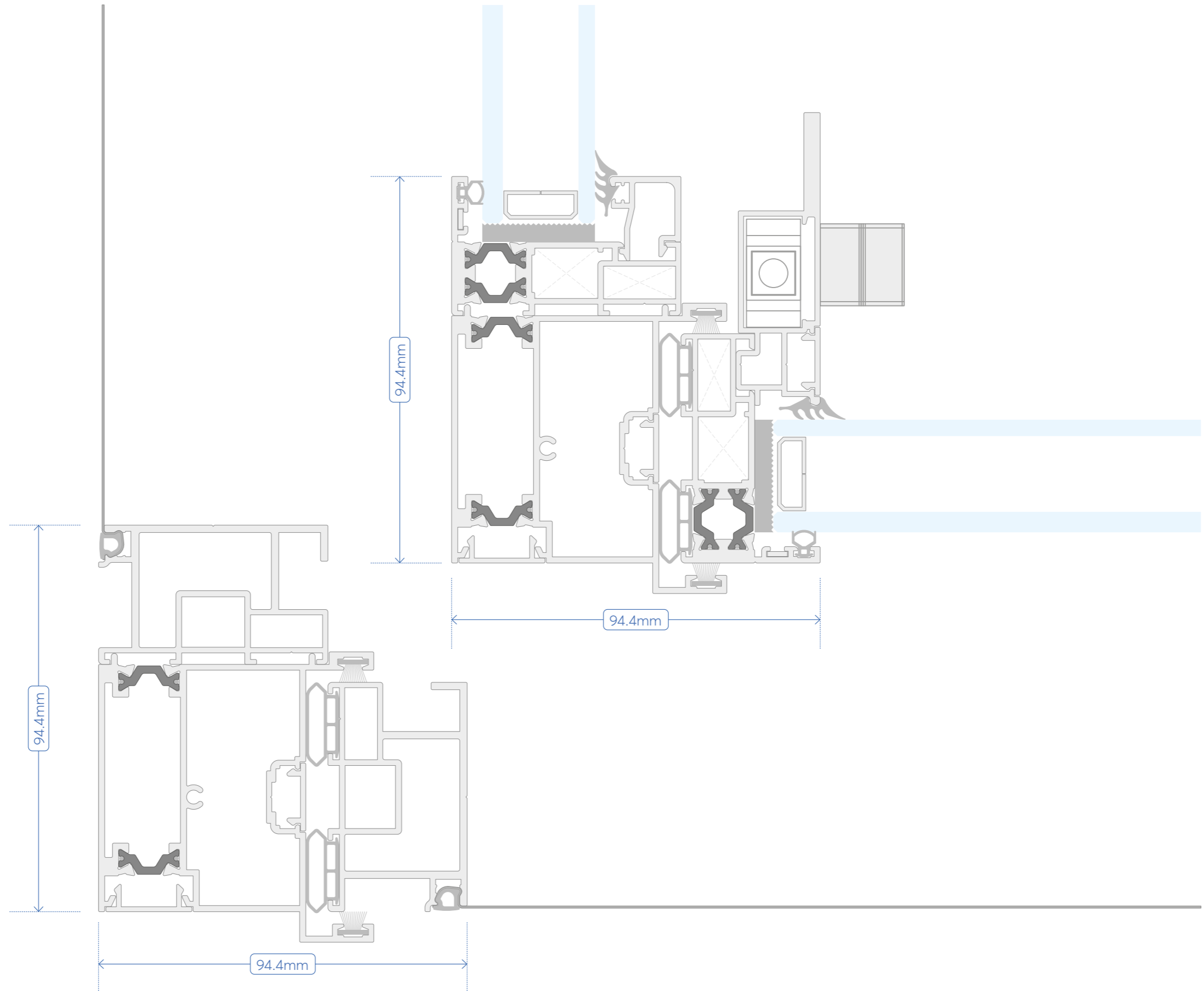



# SPACE Invisible

TYPOLGY  
ΦΥΛΛΟ ΚΑΙ ΤΥΠΟΛΟΓΙΑ  
ΤΖΑΜΙΩΝ  
SASH AND GLASS  
TYPOLOGY

TECH INFO  
ΛΕΠΤΟΜΕΡΕΙΑ  
ΛΑΒΗΣ Α  
SPACE HANDLE A  
DETAIL

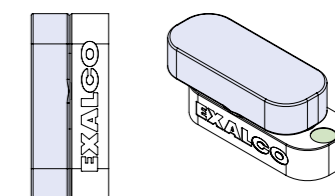

TECH INFO  
ΛΕΠΤΟΜΕΡΕΙΑ  
ΛΑΒΗΣ Β  
SPACE HANDLE B  
DETAIL

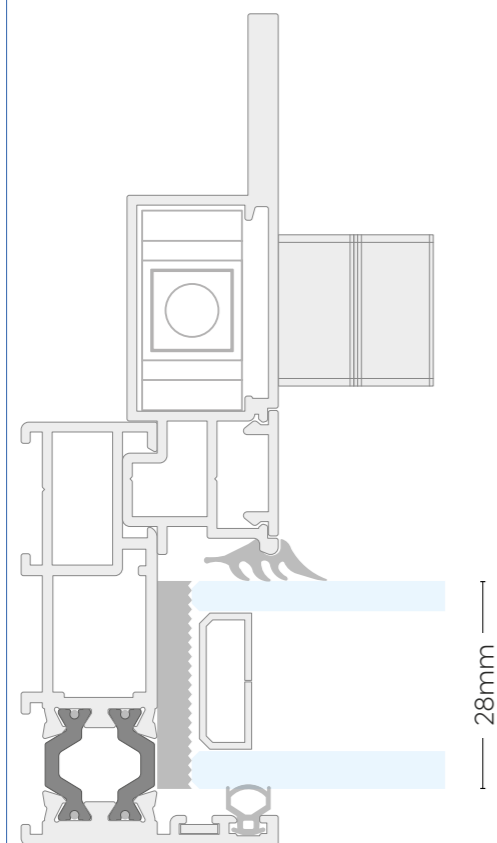
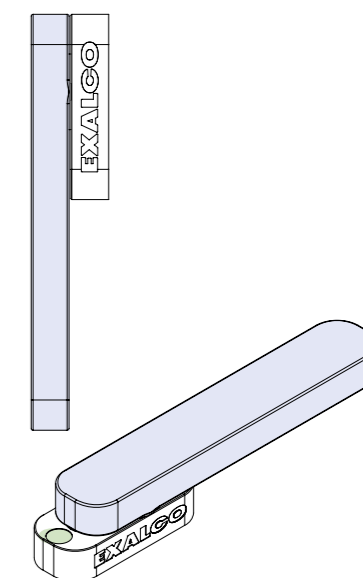

28mm

28mm

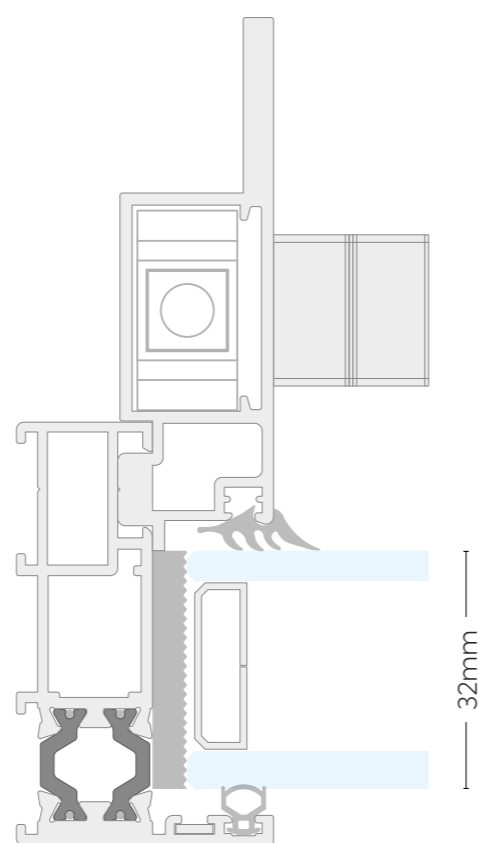

32mm

32mm

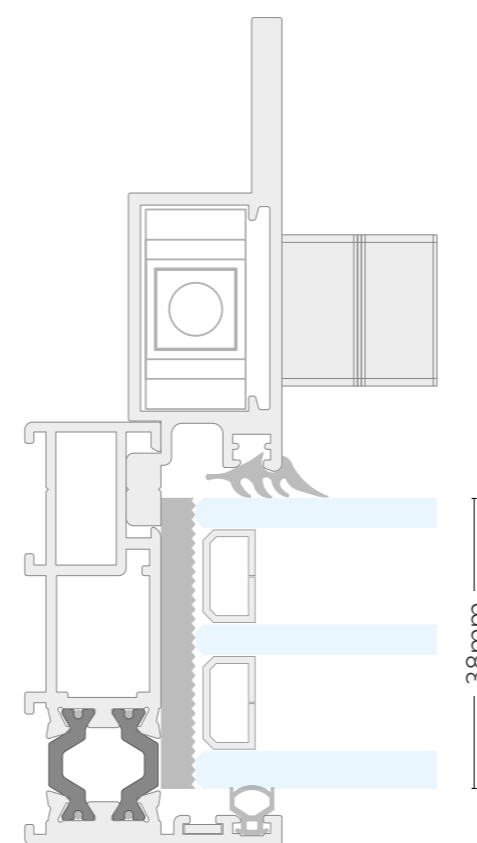

38mm

38mm

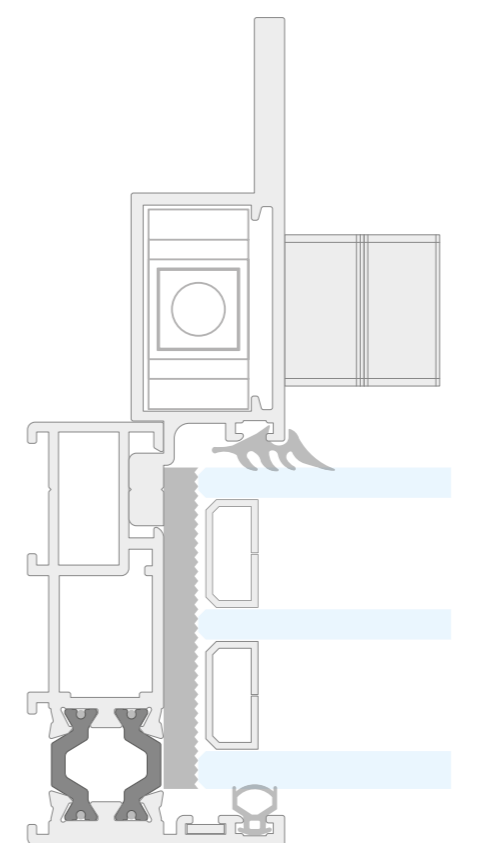

44mm

44mm

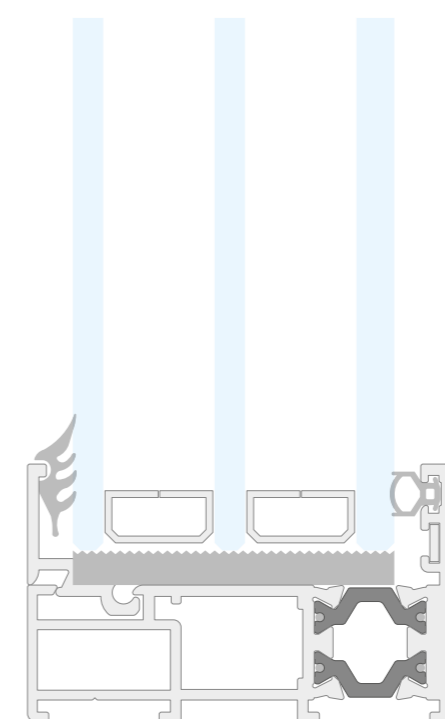
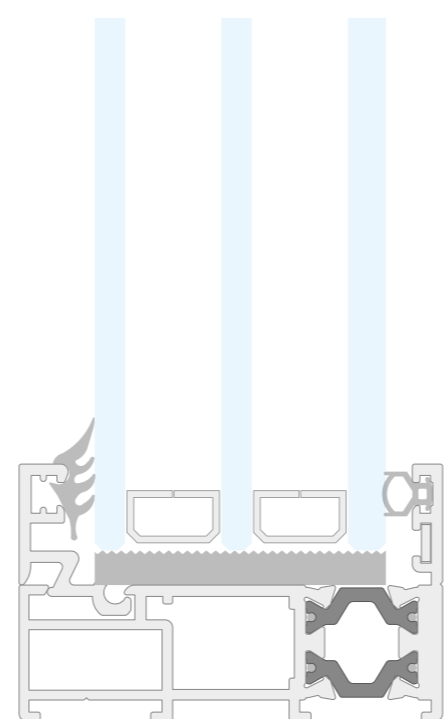
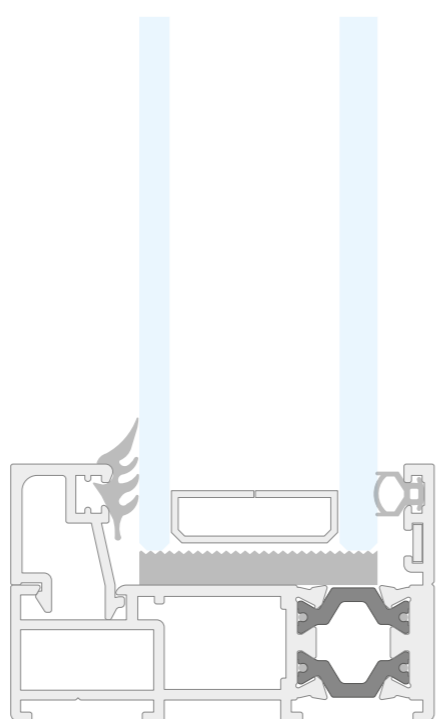
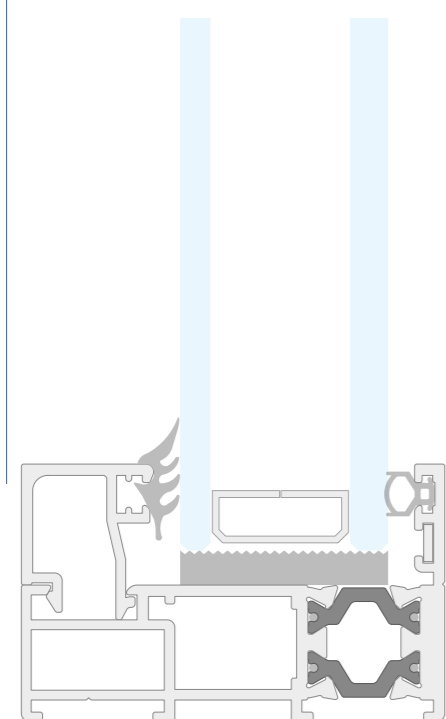

DESIGN SCALE 1:1







# SPACE Replace

SECTION

# 1.0

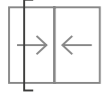

TYPOLOGY  
ΠΑΡΑΘΥΡΟ ΔΙΦΥΛΛΟ  
ΕΠΑΛΛΗΛΟ  
DOUBLE-SASH WINDOW

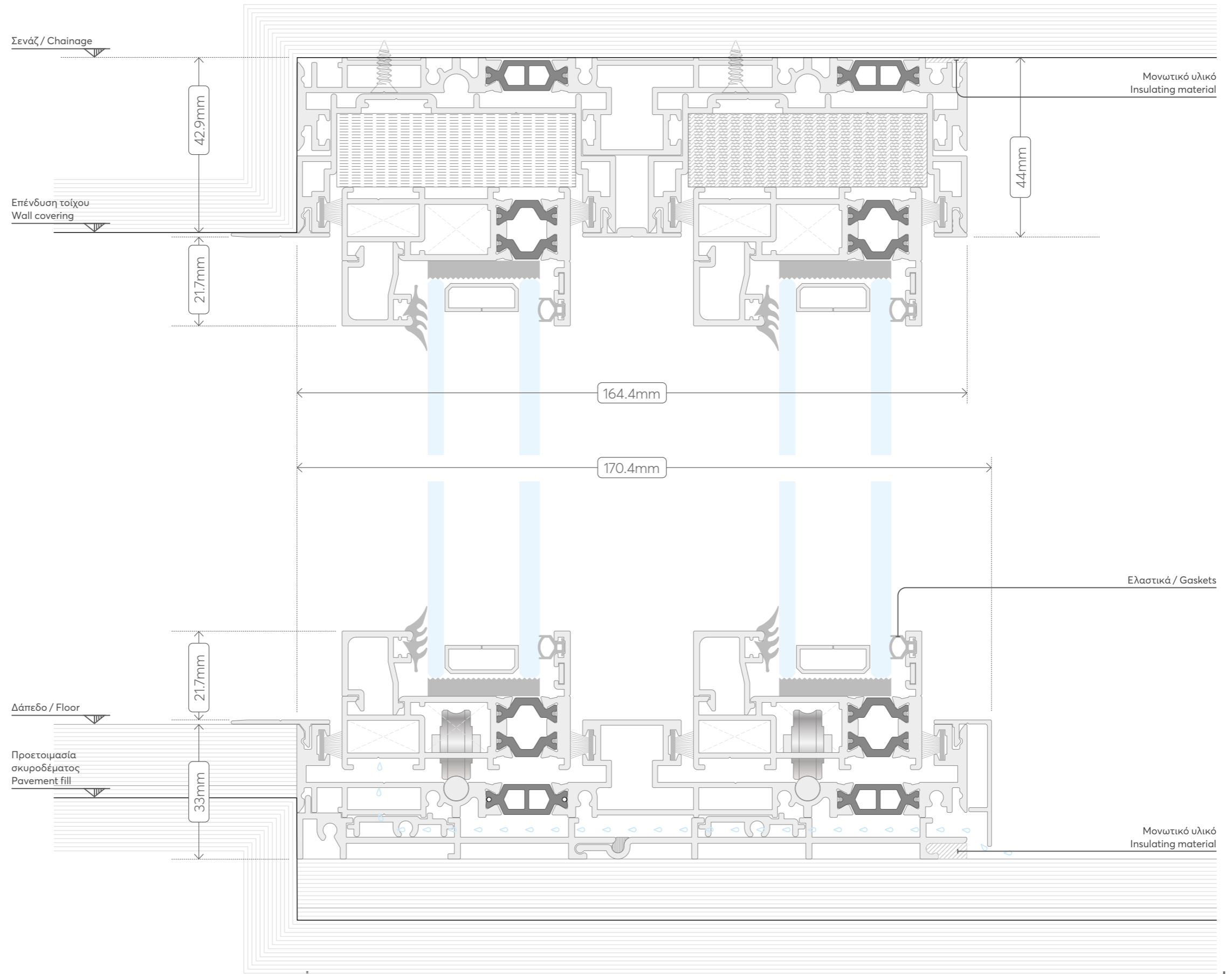

# SPACE Replace

SECTION

## 2.0

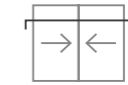

TYPOLGY  
ΠΑΡΑΘΥΡΟ ΔΙΦΥΛΛΟ  
ΕΠΑΛΛΗΛΟ  
DOUBLE-SASH WINDOW

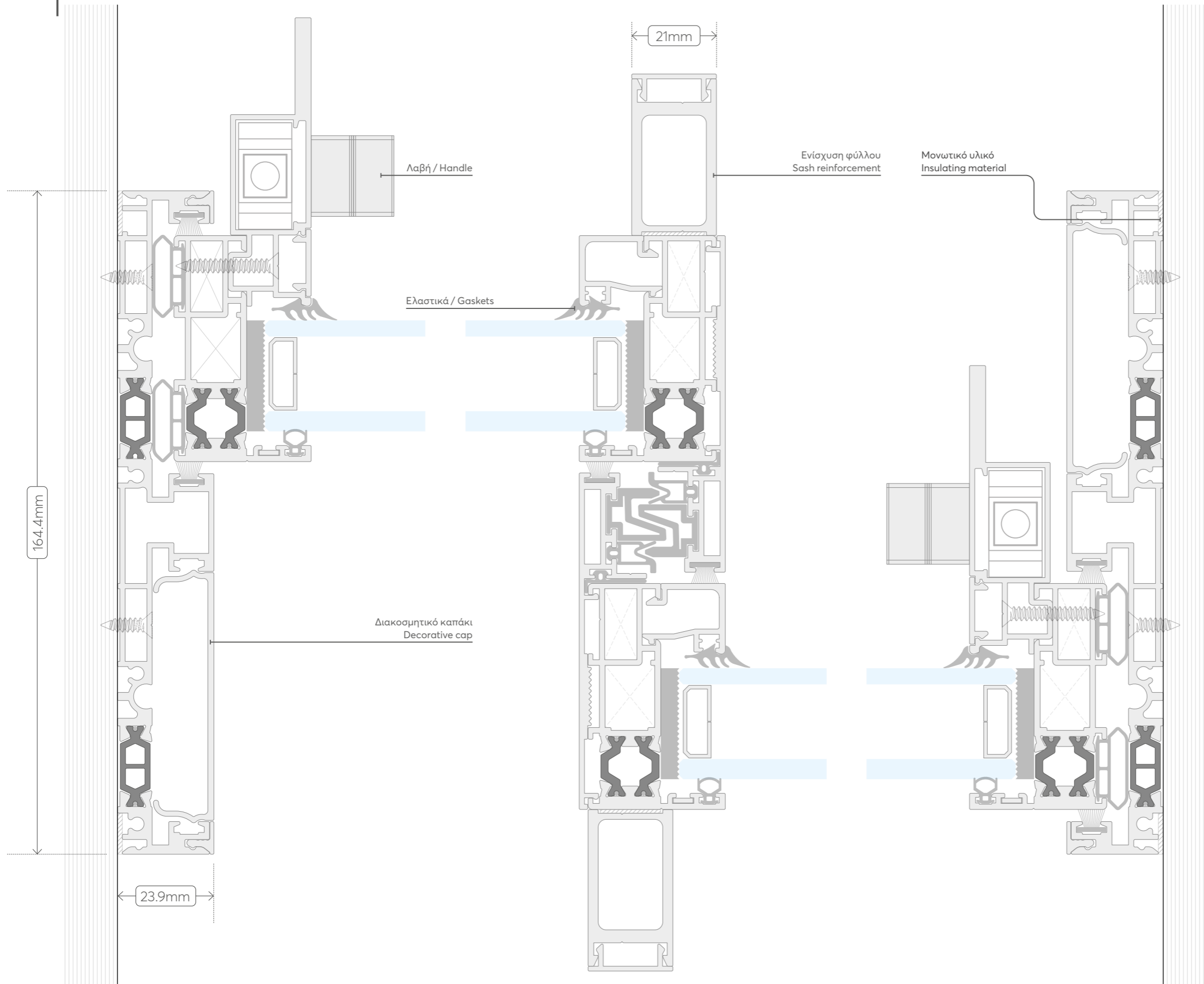

DESIGN SCALE 1:1



# SPACE Replace

SECTION

# 3.0

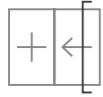

TYPOLOGY  
ΠΑΡΑΘΥΡΟ ΔΙΦΥΛΛΟ ΜΕ  
ΕΝΑ ΦΥΛΛΟ ΣΤΑΘΕΡΟ  
DOUBLE-SASH WINDOW  
WITH ONE FIXED SASH

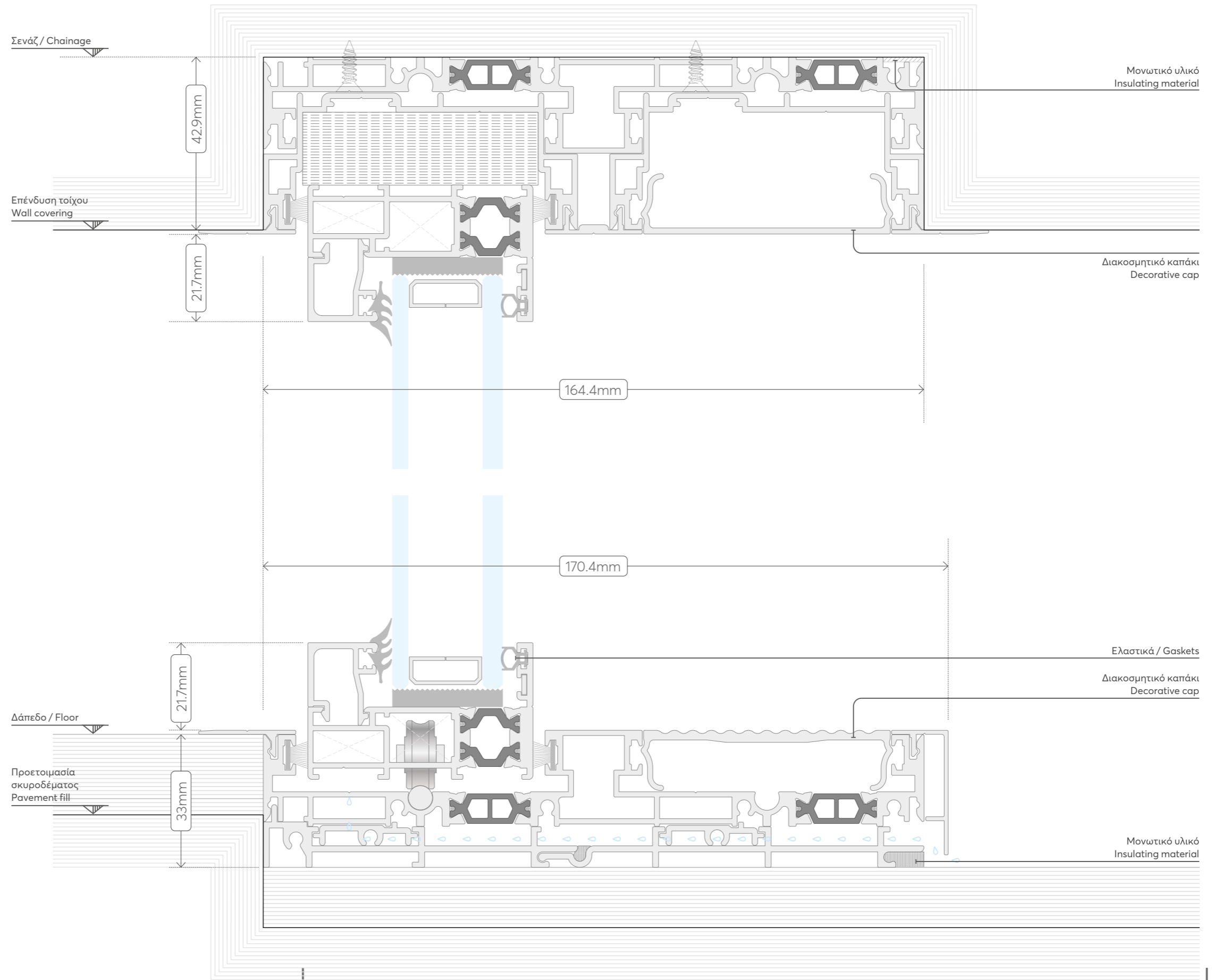

# SPACE Replace

SECTION

## 4.0



TYPOLGY  
ΠΑΡΑΘΥΡΟ ΔΙΦΥΛΛΟ ΜΕ  
ΕΝΑ ΦΥΛΛΟ ΣΤΑΘΕΡΟ  
DOUBLE-SASH WINDOW  
WITH ONE FIXED SASH

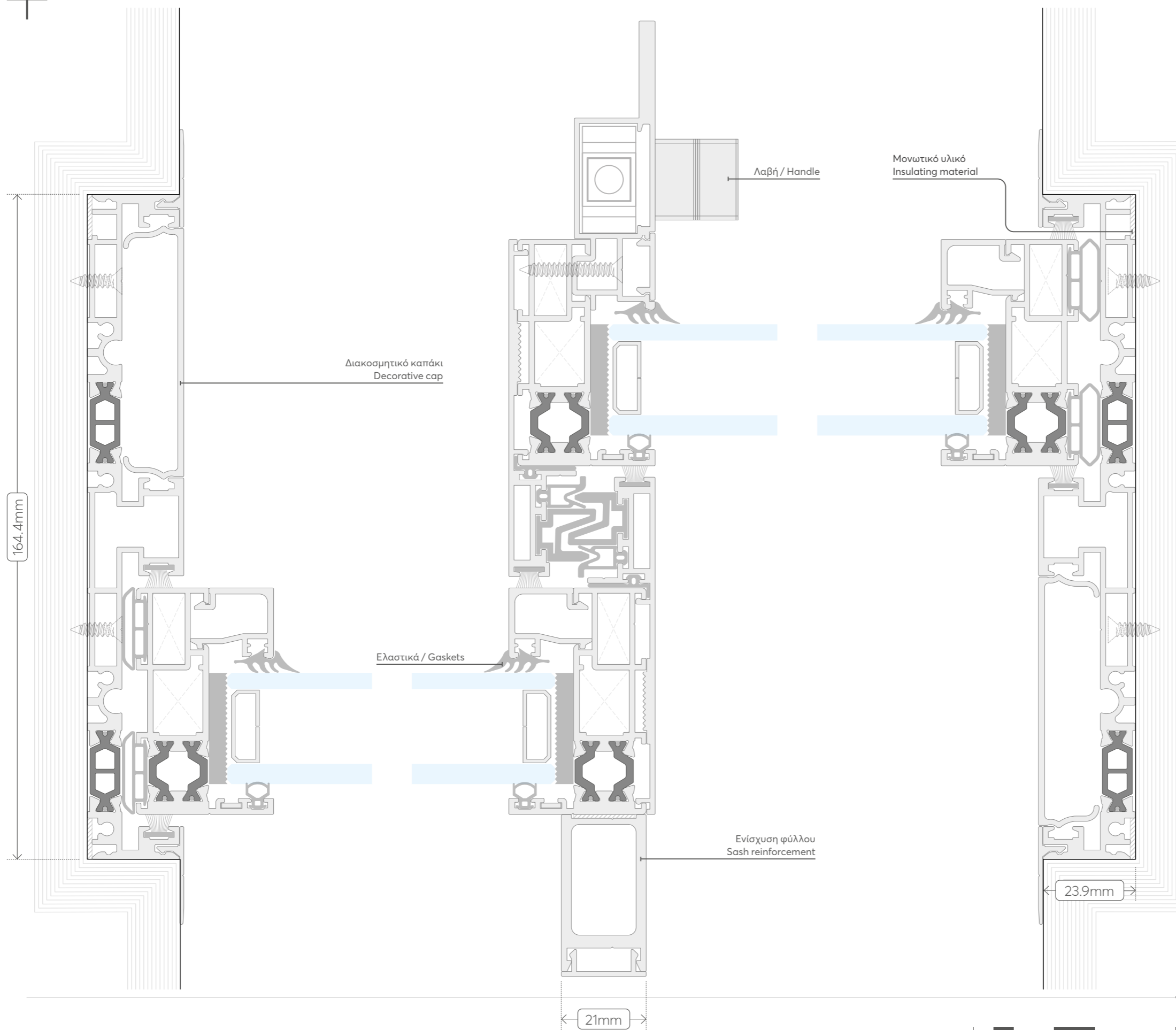

DESIGN SCALE 1:1

REPLACE

# SPACE Replace

SECTION

## 5.0

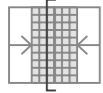

TYPOLOGY  
ΠΑΡΑΘΥΡΟ ΔΙΦΥΛΛΟ  
ΕΠΑΛΛΗΛΟ ΜΕ ΣΙΤΑ  
DOUBLE-SASH WINDOW  
WITH MOSQUITO NET

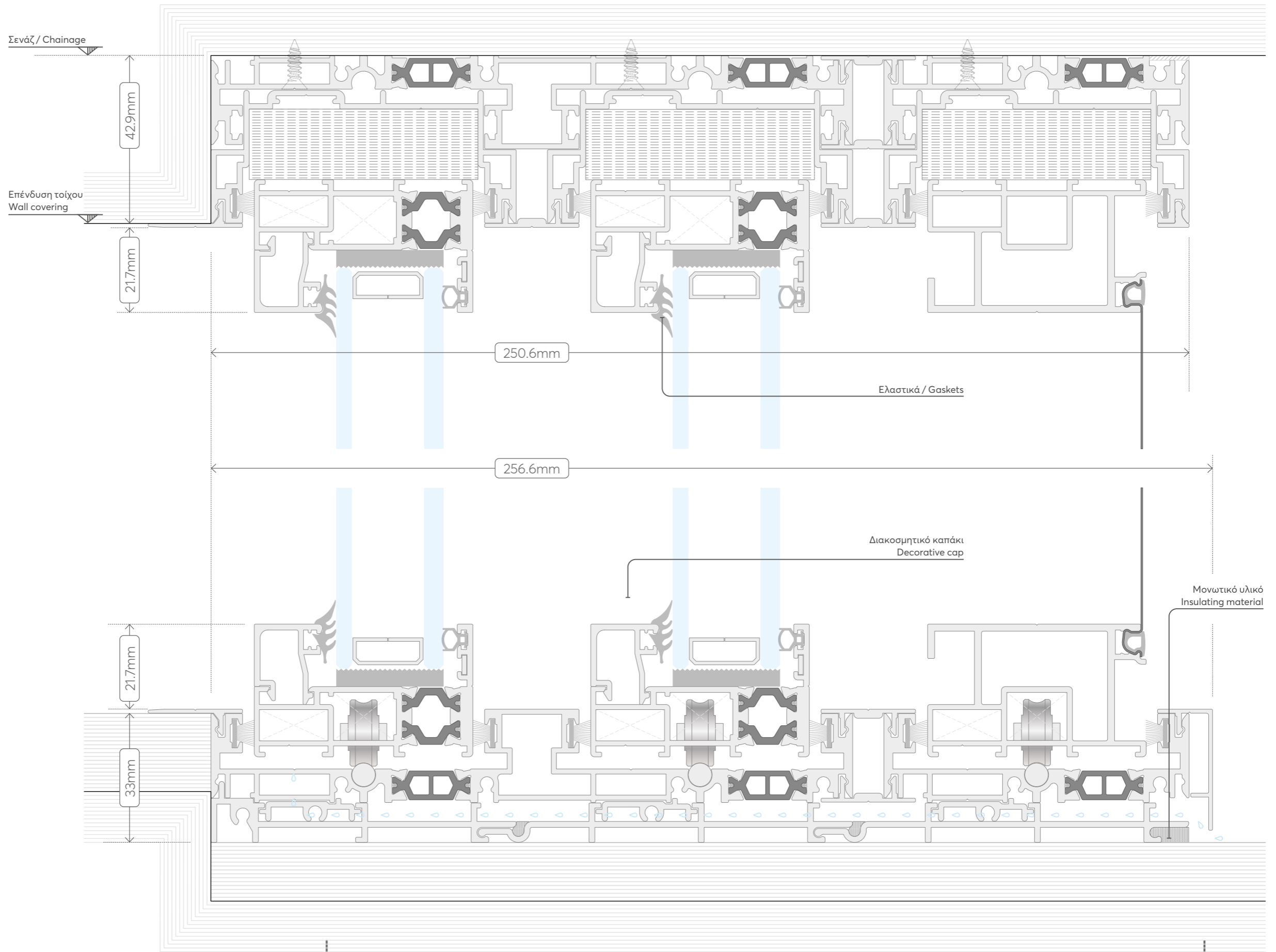



# SPACE Replace

SECTION

## 6.0

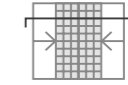

TYPOLGY  
ΠΑΡΑΘΥΡΟ ΔΙΦΥΛΛΟ  
ΕΠΑΛΛΗΛΟ ΜΕ ΣΙΤΑ  
DOUBLE-SASH WITH  
MOSQUITO NET

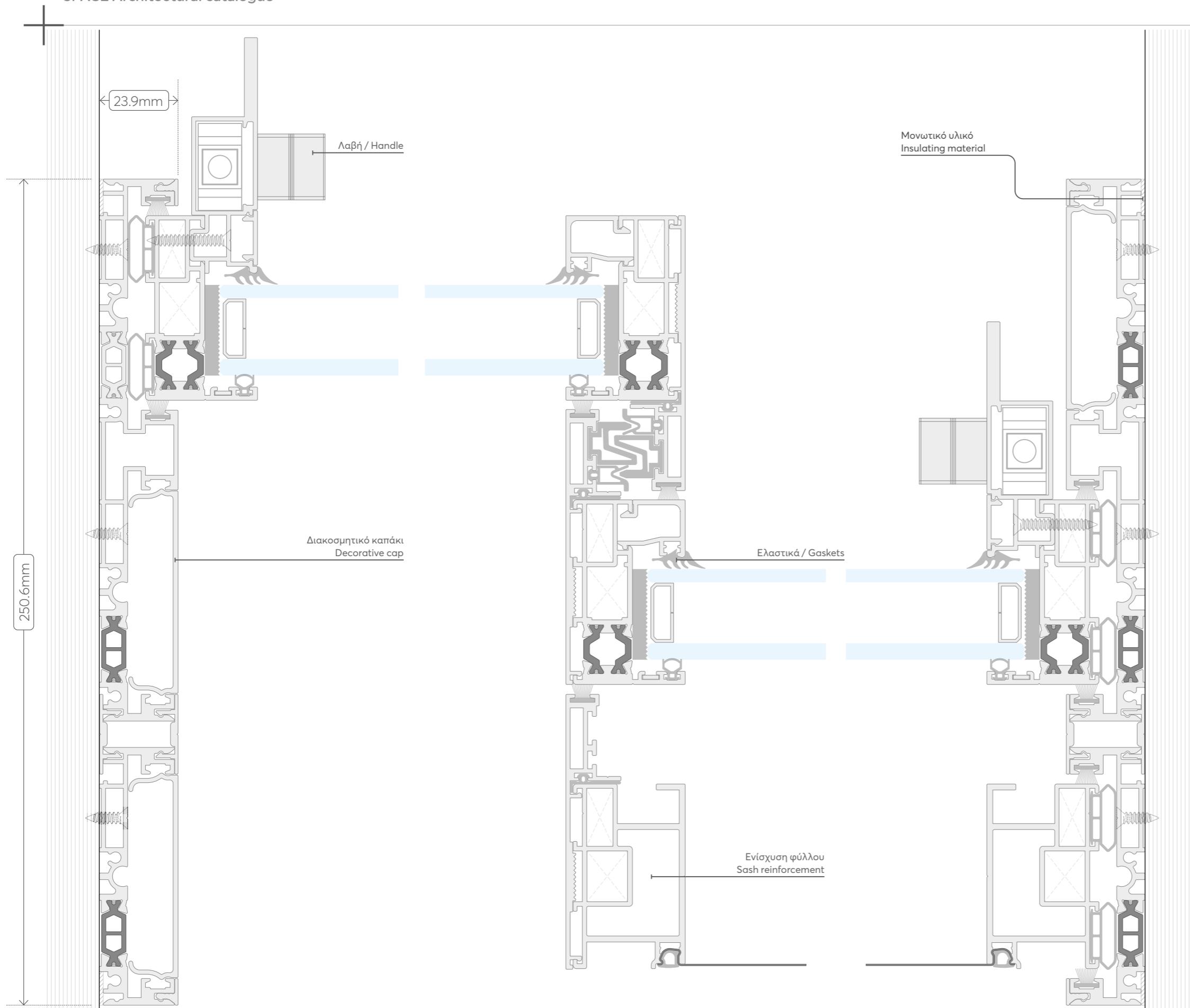

DESIGN SCALED TO FIT



# SPACE Replace

SECTION

## 7.0

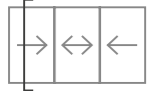

TYPOLOGY  
ΠΑΡΑΘΥΡΟ ΤΡΙΦΥΛΛΟ  
ΜΕ ΝΕΡΟΧΥΤΗ  
TRIPLE-SASH WINDOW  
WITH GUTTER

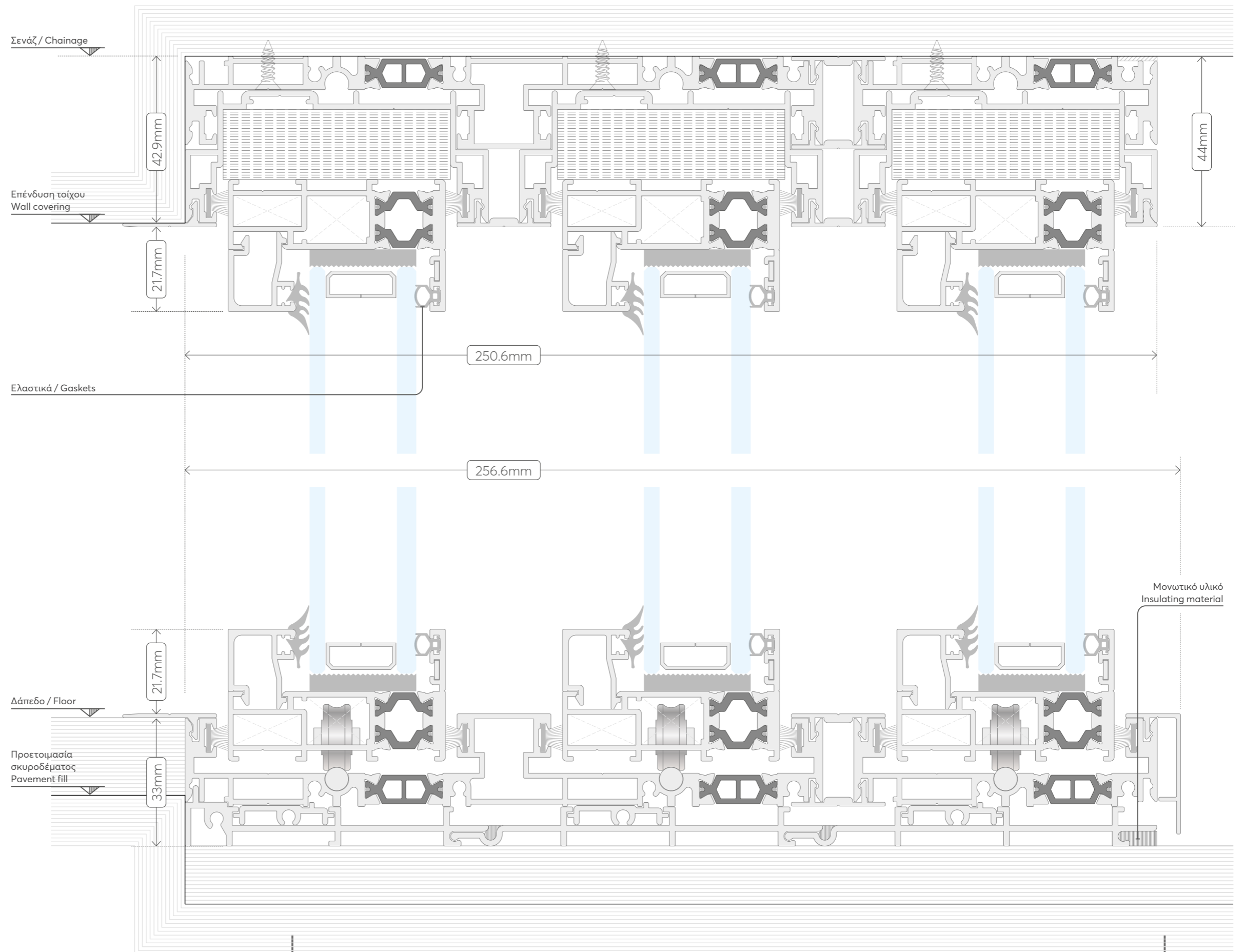

# SPACE Replace

SECTION

## 8.0

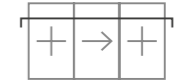

TYPOLGY  
ΠΑΡΑΘΥΡΟ ΤΡΙΦΥΛΛΟ  
ΕΠΑΛΛΗΛΟ  
TRIPLE-SASH WINDOW

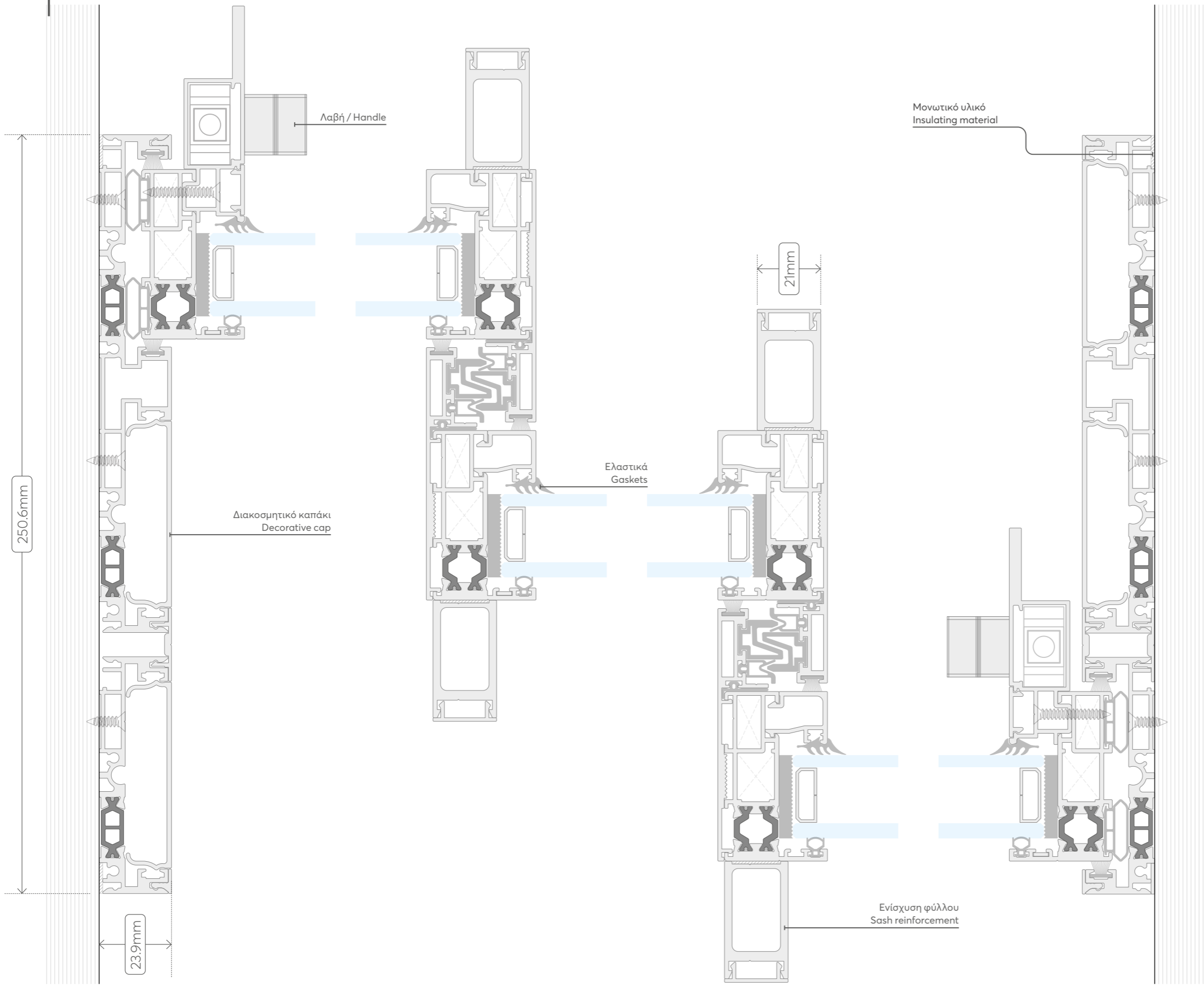

# SPACE Replace

SECTION

## 9.0

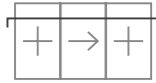

TYPOLOGY  
ΠΑΡΑΘΥΡΟ ΤΡΙΦΥΛΛΟ  
ΜΕ ΕΝΑ ΚΙΝΗΤΟ ΦΥΛΛΟ  
TRIPLE-SASH WINDOW  
ON DOUBLE RAIL WITH  
ONE MOVING SASH

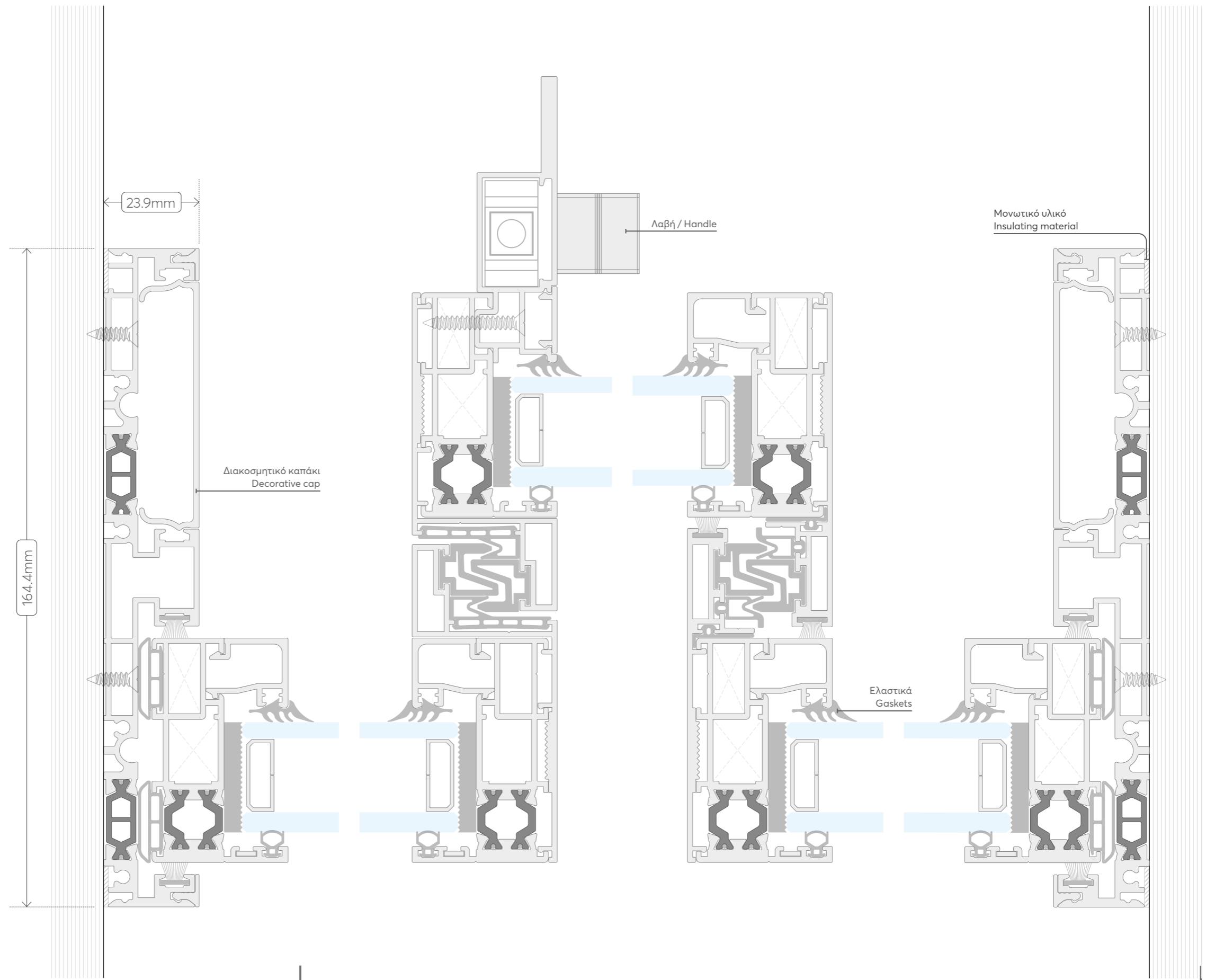

# SPACE Replace

SECTION

# 10.0



TYPOLGY  
ΠΑΡΑΘΥΡΟ  
ΜΟΝΟΦΥΛΛΟ ΧΩΝΕΥΤΟ  
SINGLE-SASH  
RECESSED WINDOW

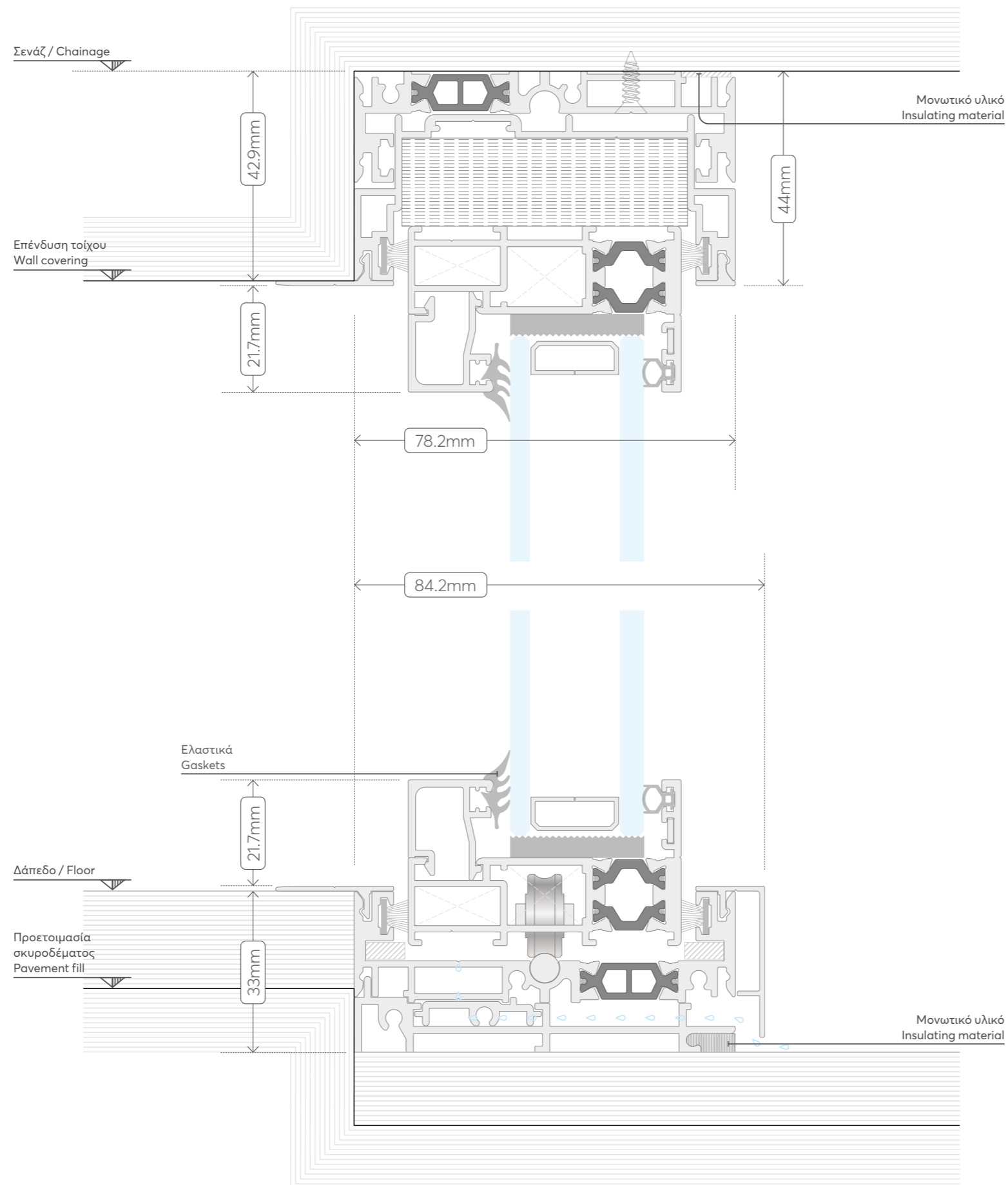

# SPACE Replace

SECTION

# 11.0



TYPOLGY  
ΠΑΡΑΘΥΡΟ  
ΜΟΝΟΦΥΛΛΟ ΧΩΝΕΥΤΟ  
SINGLE-SASH RECESSED  
WINDOW

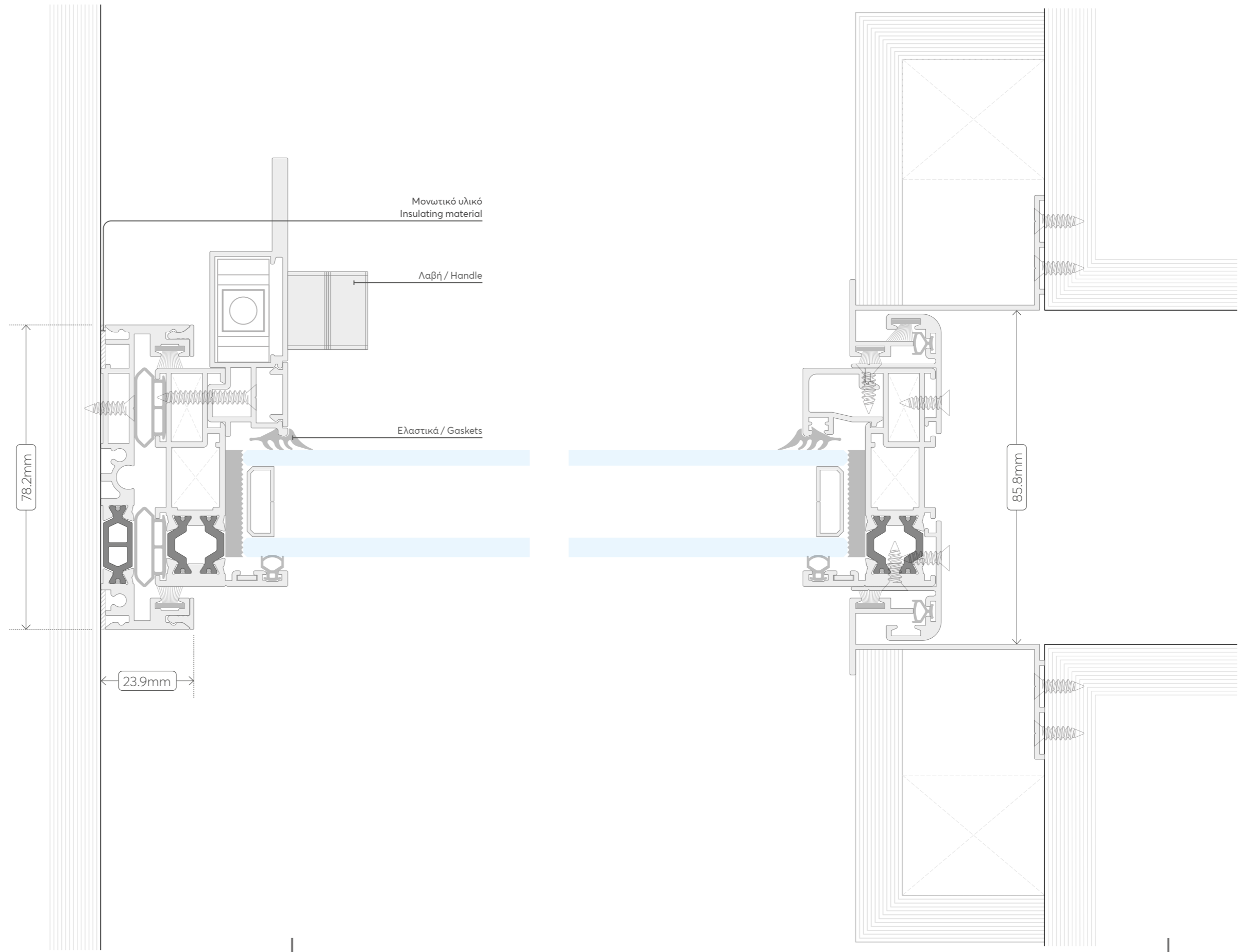

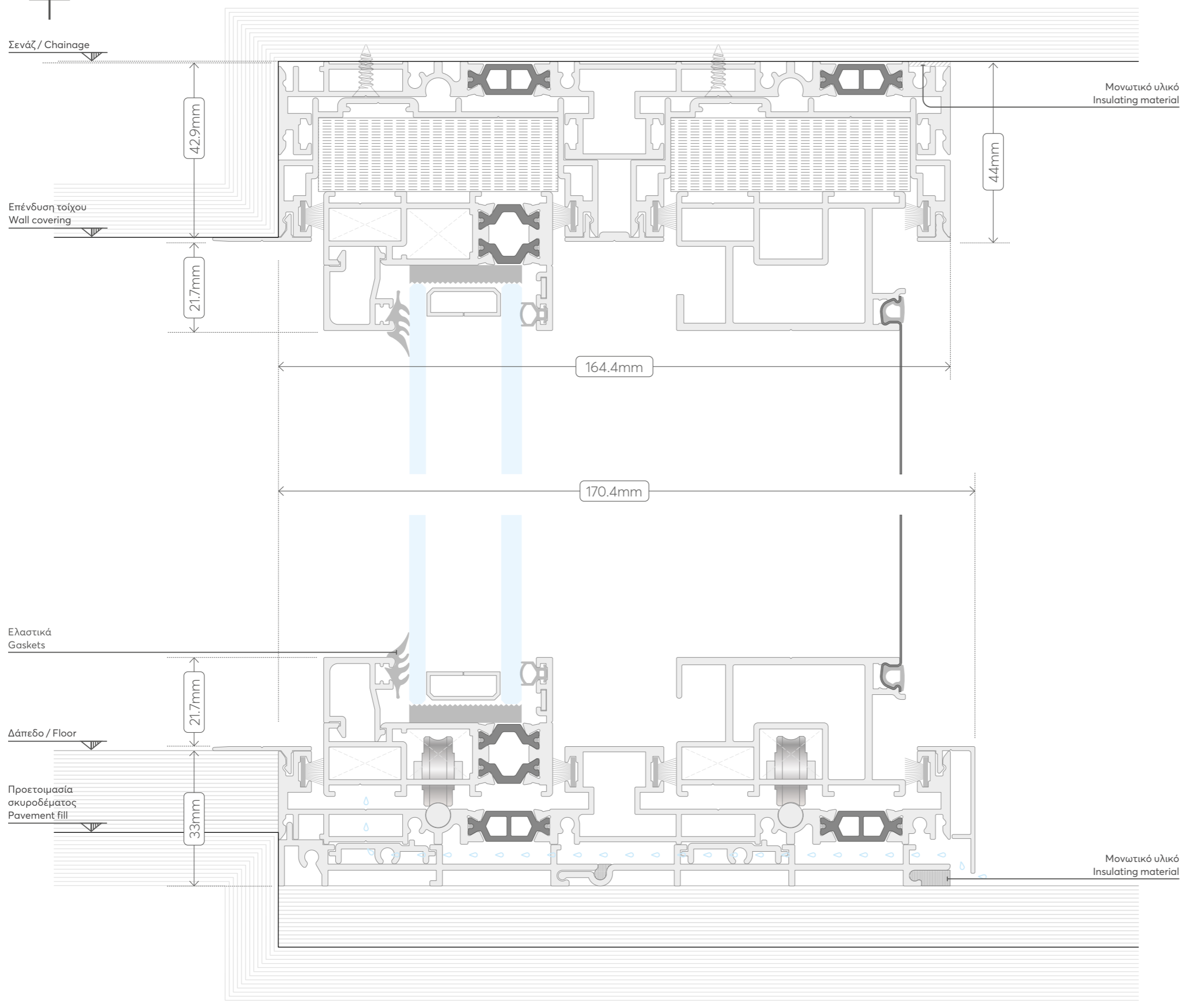

# SPACE Replace

SECTION

## 12.0

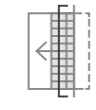

TYPOLGY  
 ΠΑΡΑΘΥΡΟ  
 ΜΟΝΟΦΥΛΛΟ  
 ΧΩΝΕΥΤΟ ΜΕ ΣΙΤΑ  
 SINGLE-SASH RECESSED  
 WINDOW WITH  
 MOSQUITO NET

# SPACE Replace

SECTION

# 13.0

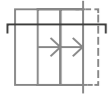

TYPOLOGY  
ΠΑΡΑΘΥΡΟ  
ΜΟΝΟΦΥΛΛΟ ΧΩΝΕΥΤΟ  
ΜΕ ΣΙΤΑ  
SINGLE-SASH RECESSED  
WINDOW WITH  
MOSQUITO NET

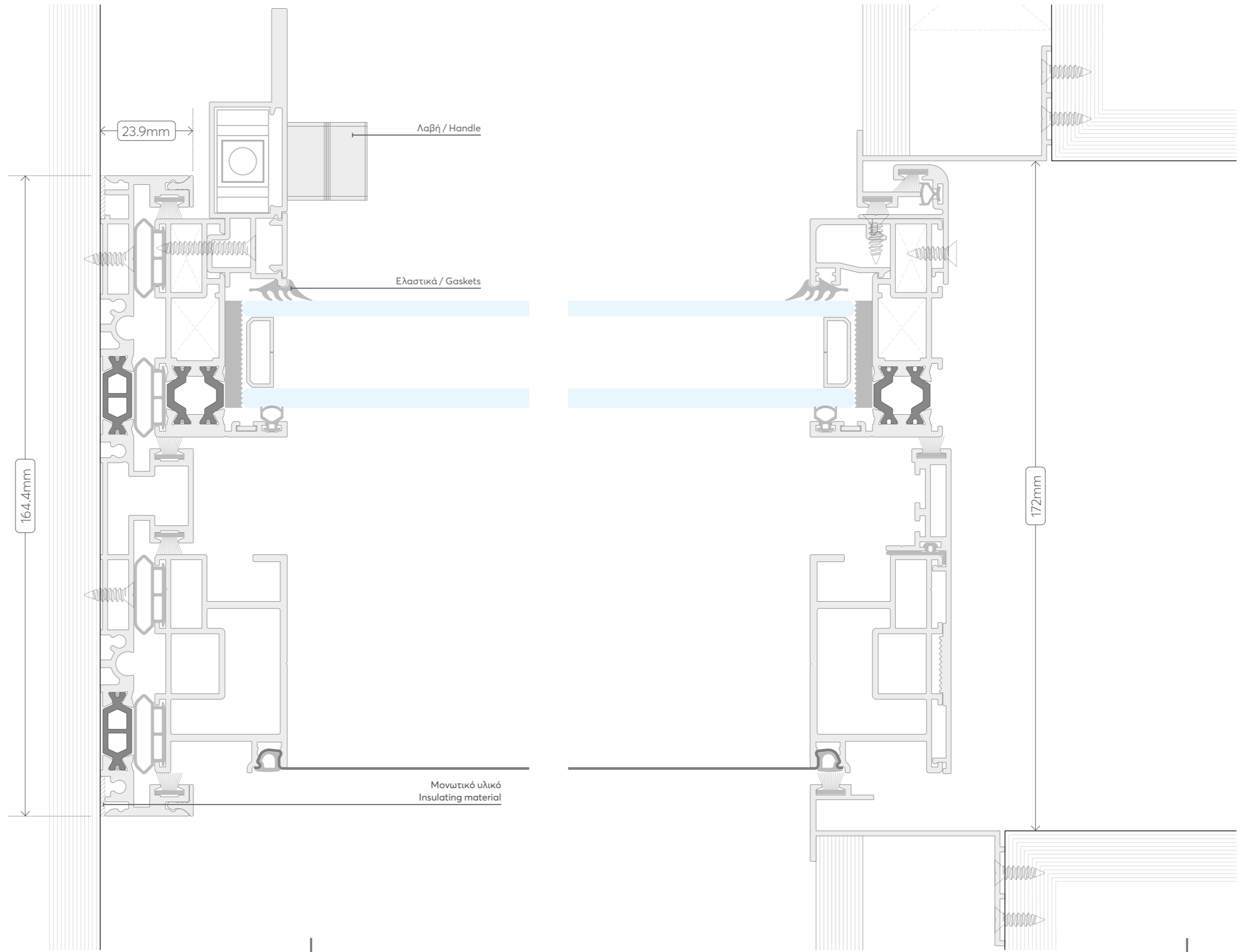



# SPACE Replace

SECTION

# 14.0

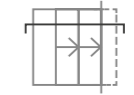

TYPOLGY  
ΠΑΡΑΘΥΡΟ ΔΙΦΥΛΛΟ  
ΧΩΝΕΥΤΟ  
ΠΑΡΑΣΥΡΟΜΕΝΟ  
DOUBLE-SASH RECESSED  
WINDOW

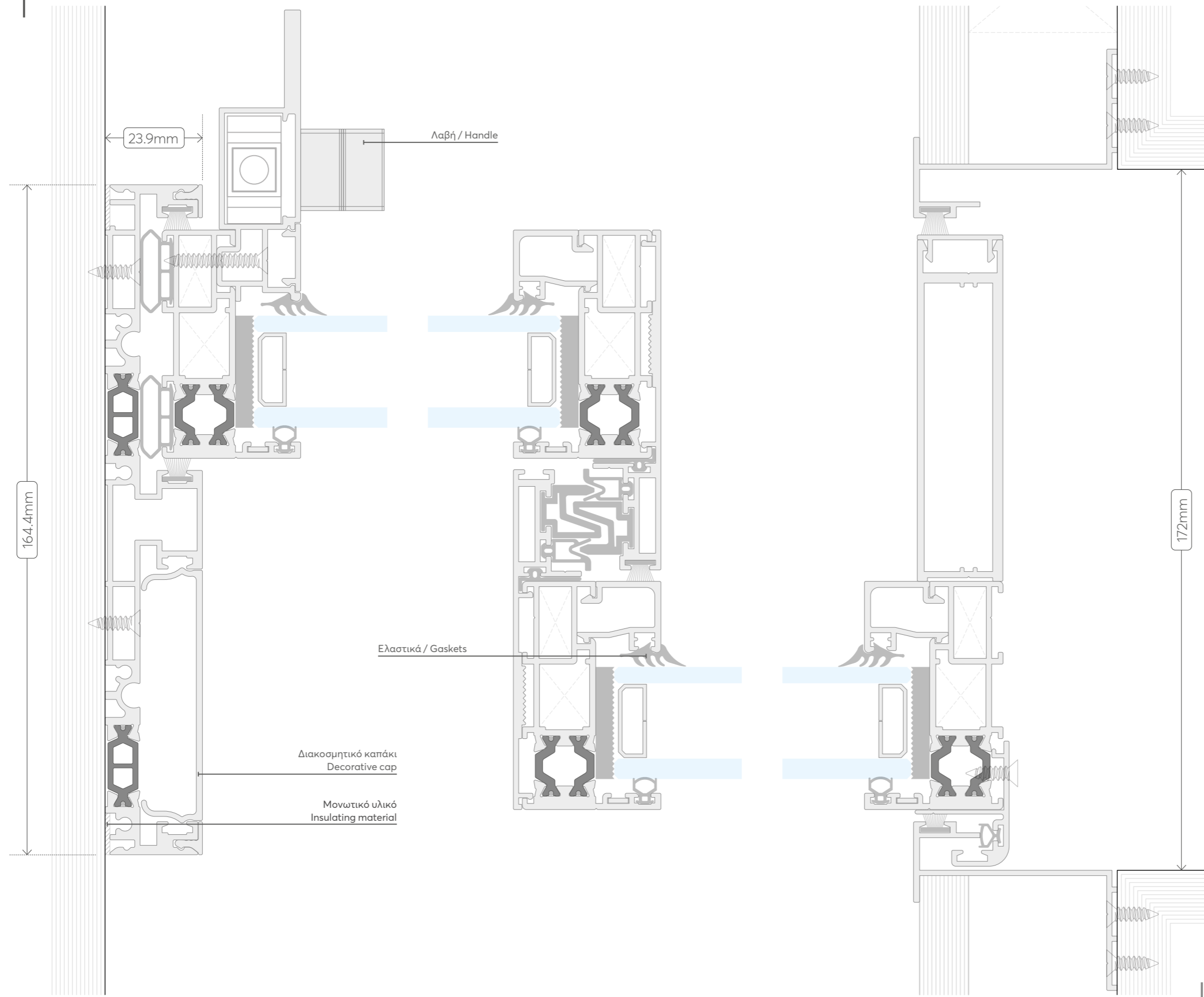

DESIGN SCALE 1:1



# SPACE Replace

SECTION

# 15.0

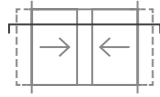

TYPOLGY  
ΠΑΡΑΘΥΡΟ ΔΙΦΥΛΛΟ  
ΧΩΝΕΥΤΟ ΦΙΛΗΤΟ  
DOUBLE-SASH RECESSED  
WINDOW WITH  
CENTRAL LOCK

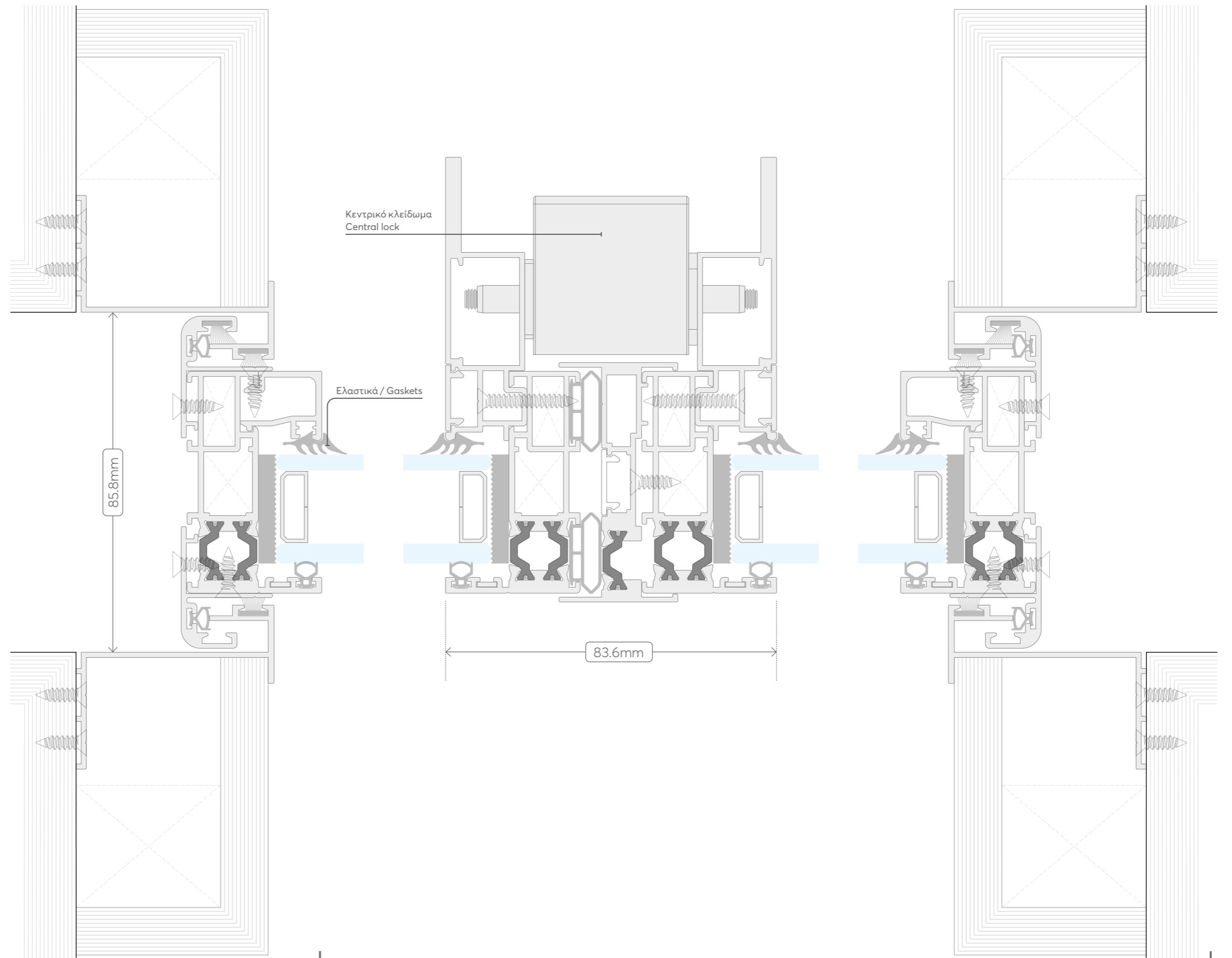

# SPACE Replace

SECTION

# 16.0

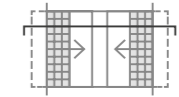

TYPOLGY  
ΠΑΡΑΘΥΡΟ ΔΙΦΥΛΛΟ  
ΧΩΝΕΥΤΟ ΦΙΛΗΤΟ  
ΜΕ ΣΙΤΑ  
DOUBLE-SASH RECESSED  
WINDOW WITH CENTRAL  
LOCK AND MOSQUITO  
NET

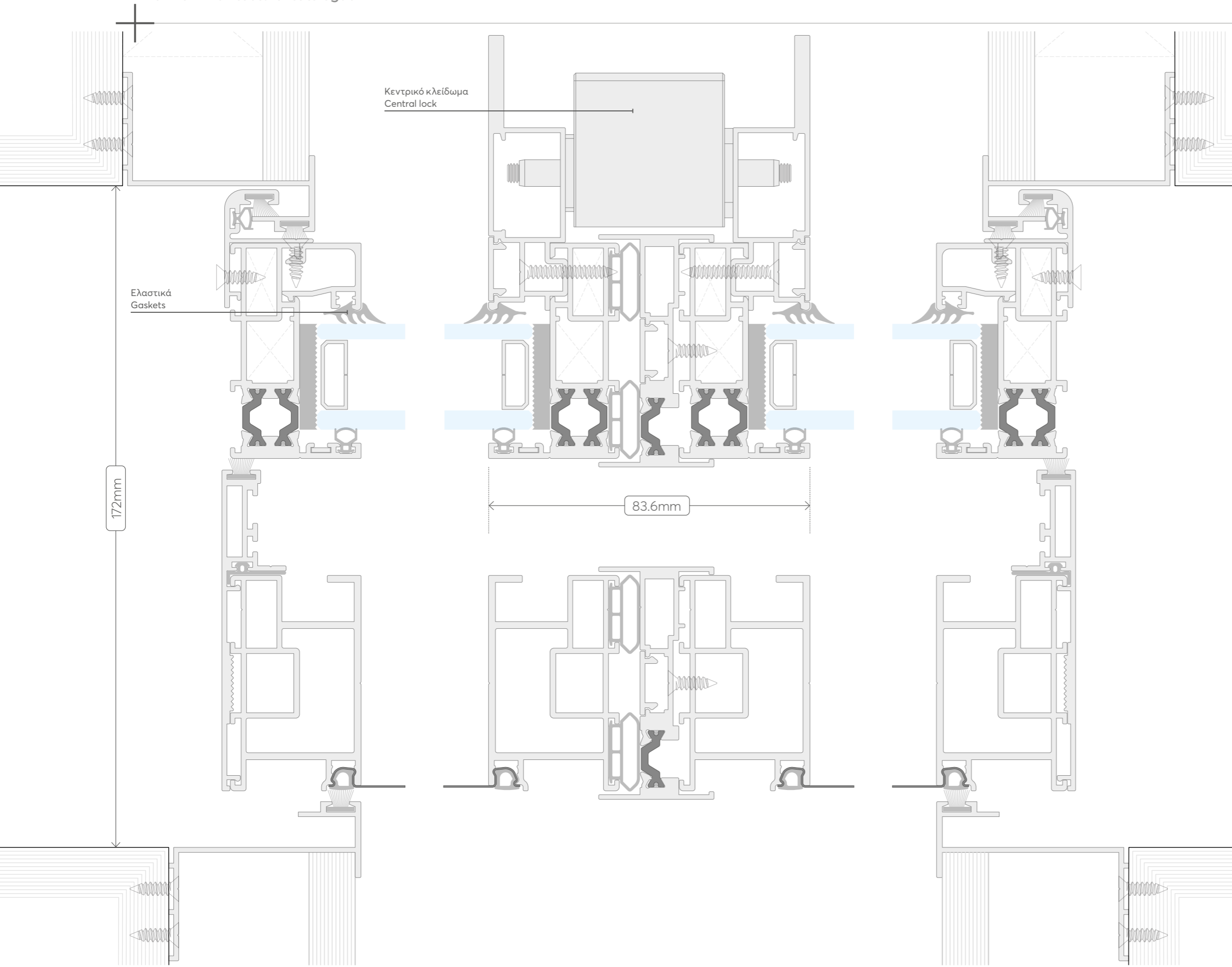

DESIGN SCALE 1:1

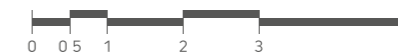

# SPACE Replace

SECTION

# 17.0

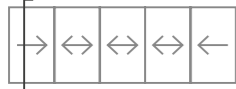

TYPOLOGY  
ΠΕΝΤΑΦΥΛΛΟ  
ΠΑΡΑΘΥΡΟ  
FIVE-SASH WINDOW

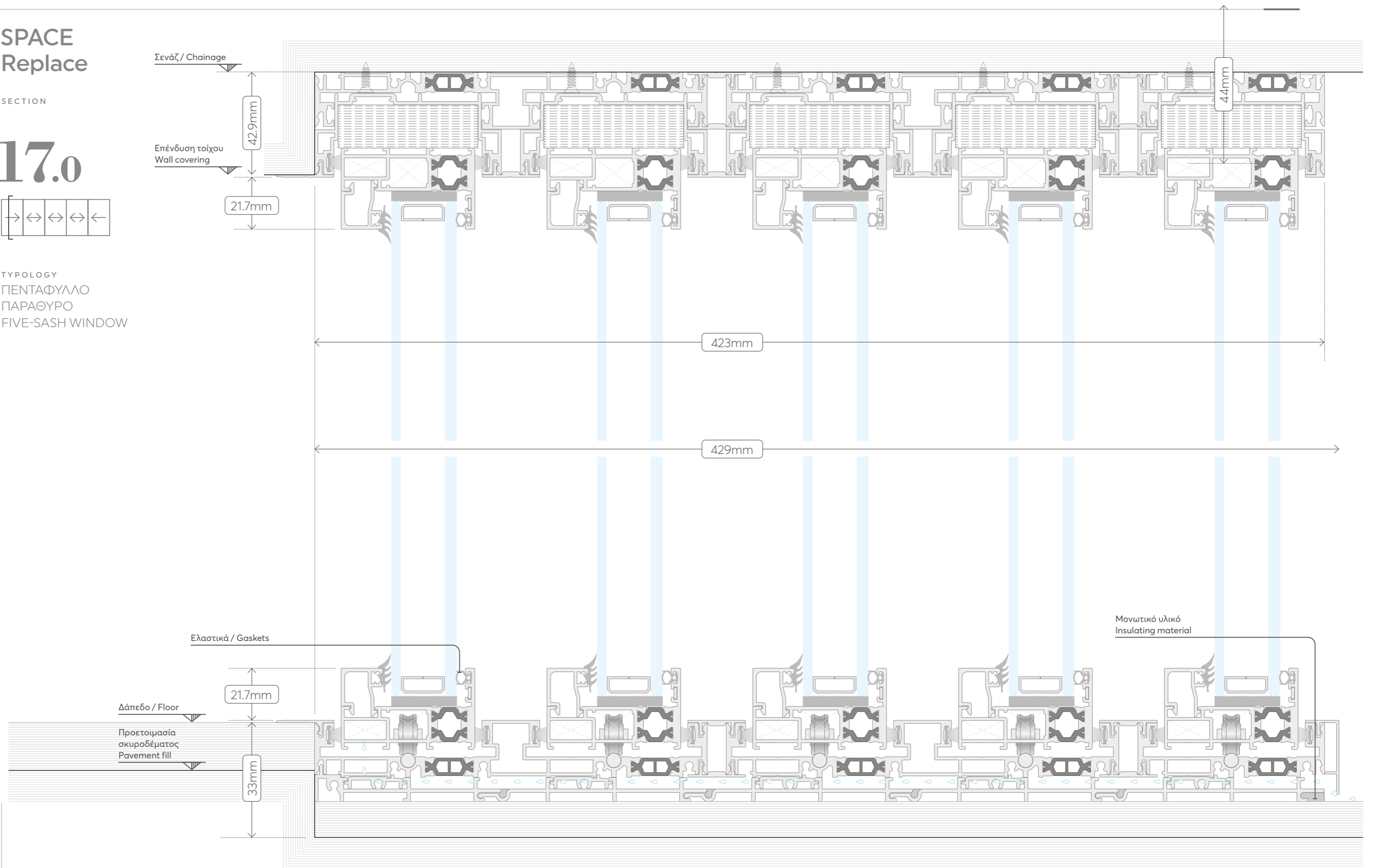

# SPACE Replace

SECTION

# 18.0



TYPOLGY  
ΠΕΝΤΑΦΥΛΛΟ  
ΠΑΡΑΘΥΡΟ  
FIVE-SASH WINDOW

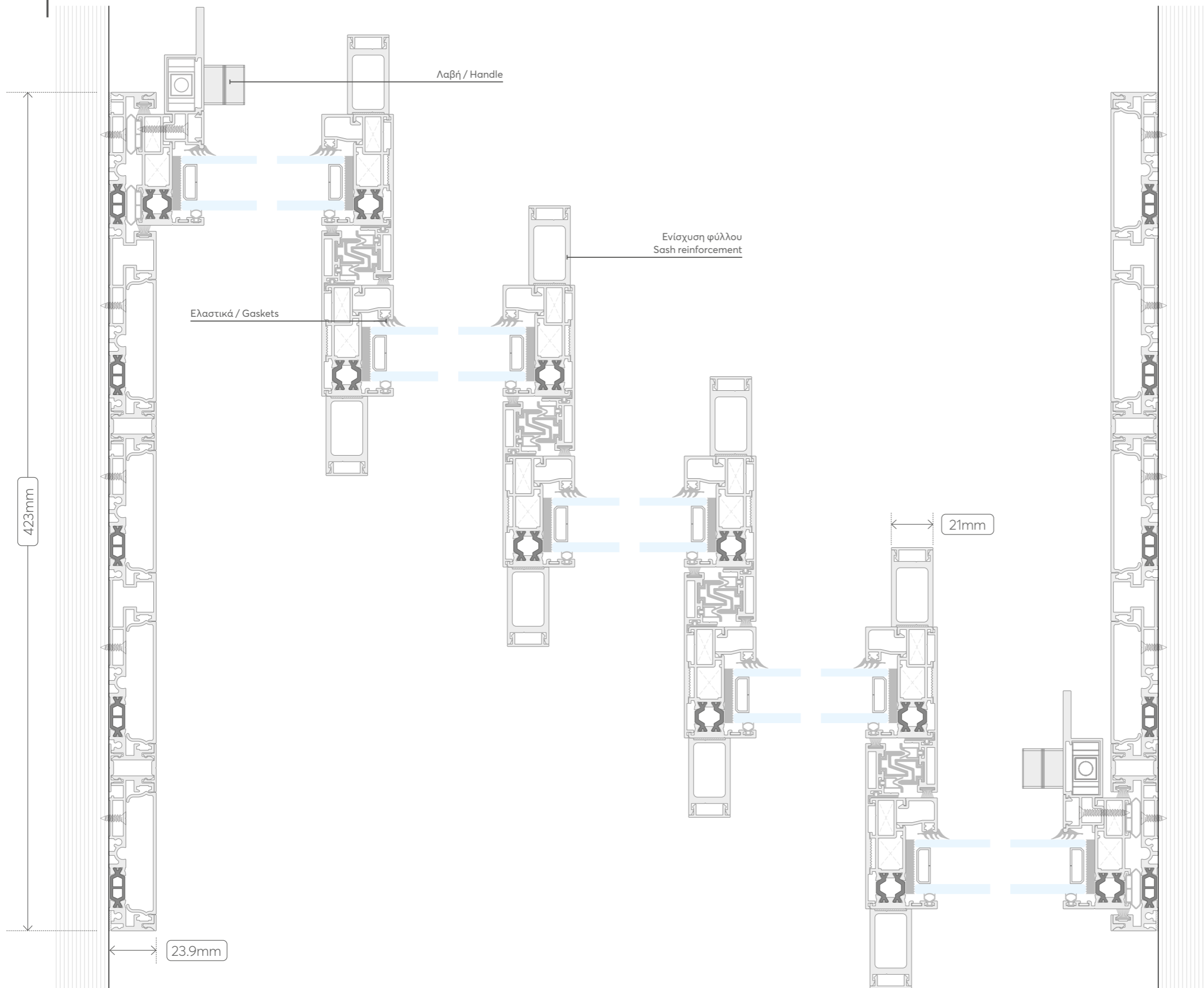

DESIGN SCALED TO FIT

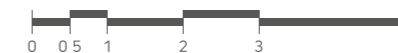

# SPACE Replace

TYPOLOGY  
ΦΥΛΛΟ ΚΑΙ ΤΥΠΟΛΟΓΙΑ  
ΤΖΑΜΙΩΝ  
SASH AND GLASS  
TYPOLOGY

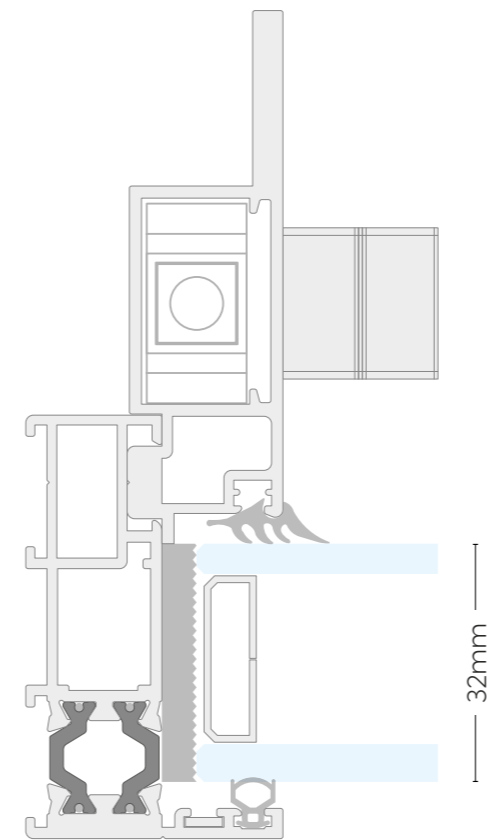
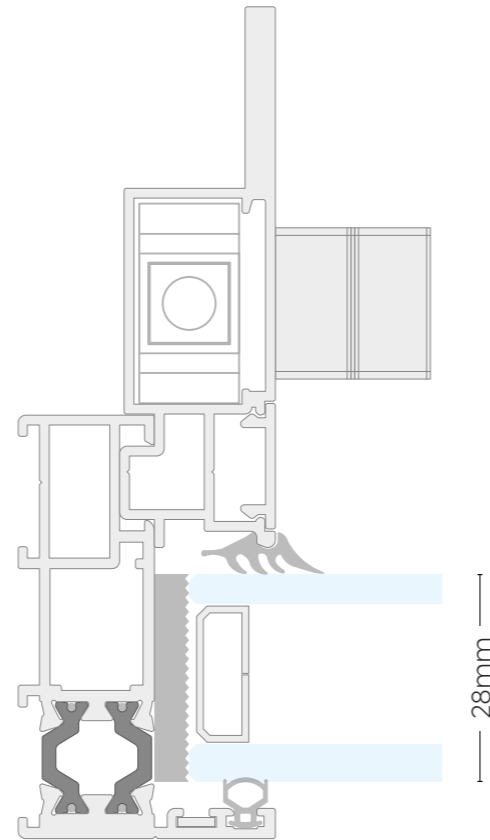

28mm

32mm

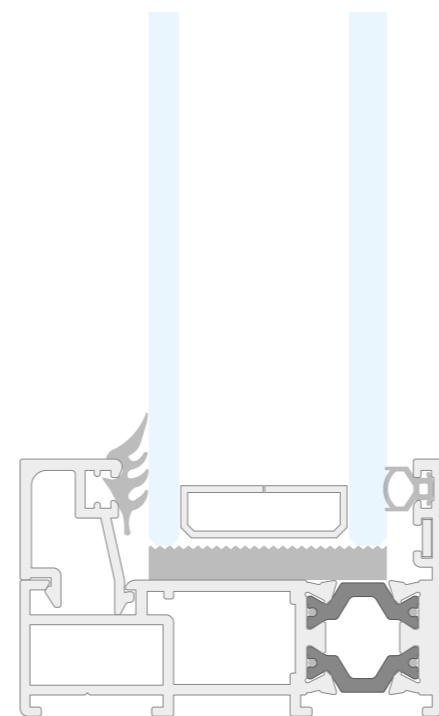
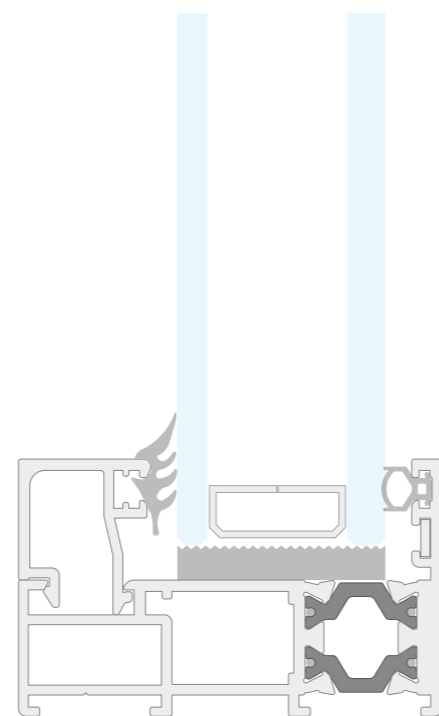

# SPACE Replace

TYPOLGY  
ΦΥΛΛΟ ΚΑΙ ΤΥΠΟΛΟΓΙΑ  
ΤΖΑΜΙΩΝ  
SASH AND GLASS  
TYPOLOGY

TECH INFO  
ΛΕΠΤΟΜΕΡΕΙΑ  
ΛΑΒΗΣ A  
SPACE HANDLE A  
DETAIL

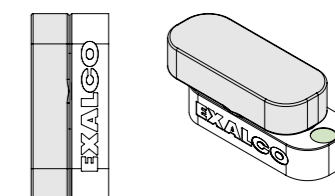

TECH INFO  
ΛΕΠΤΟΜΕΡΕΙΑ  
ΛΑΒΗΣ B  
SPACE HANDLE B  
DETAIL

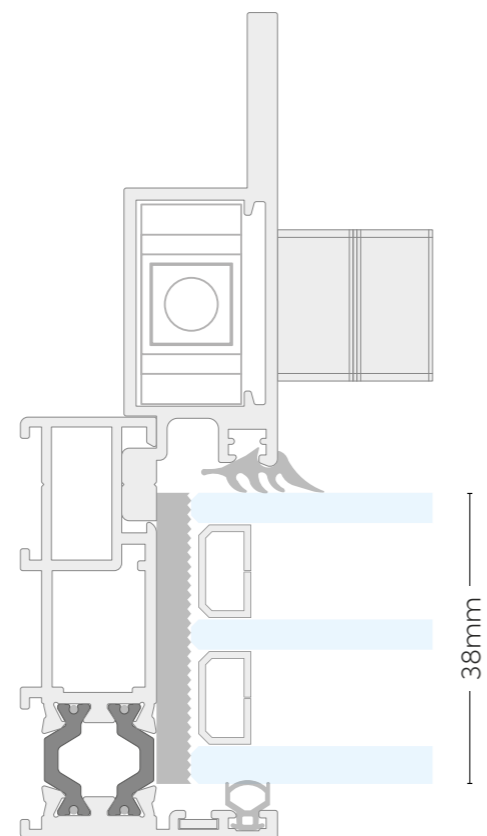
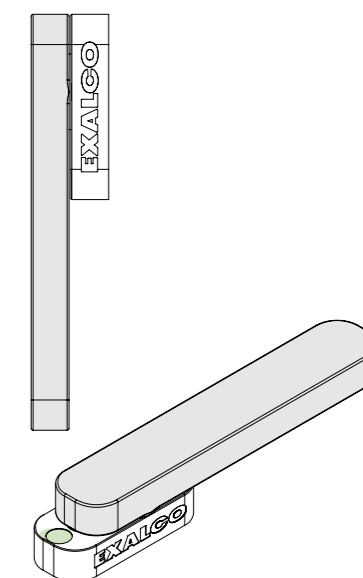

38mm

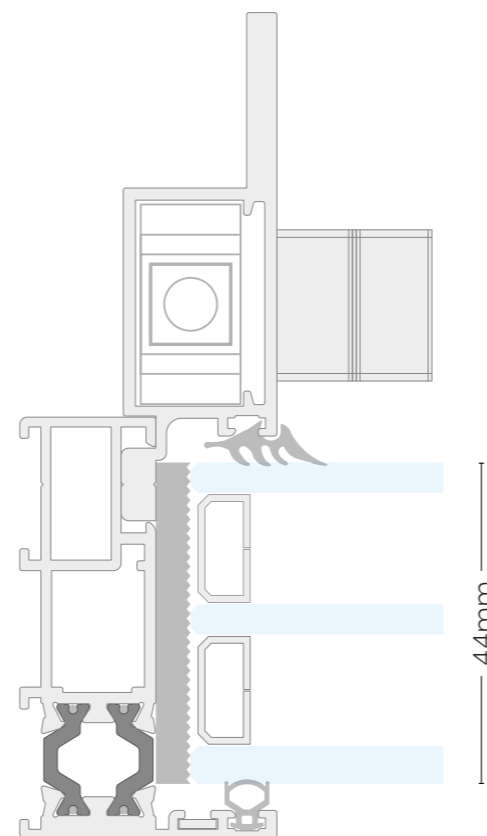

44mm

38mm

44mm

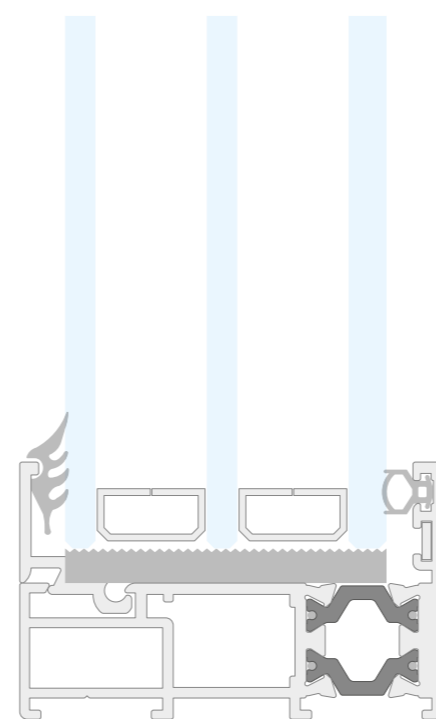
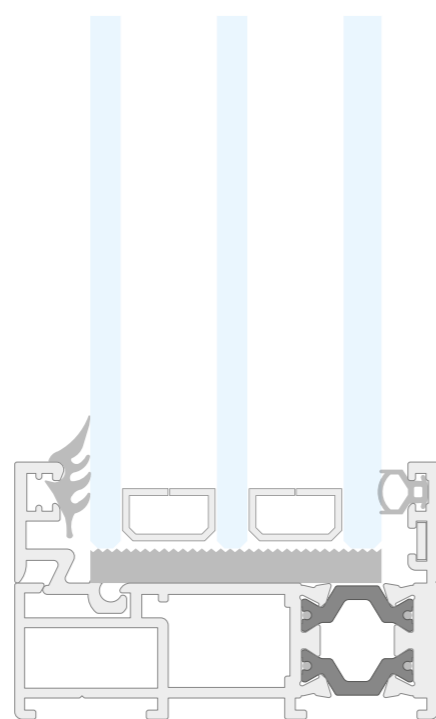

### SPACE INSIDE OUT

Τα κάθετα προφίλ αποτελούν τα μόνα ορατά προφίλ αλουμινίου του συστήματος.

The vertical profiles are the only visible aluminium profiles of the system.

Σελ. / Pg. 9-35

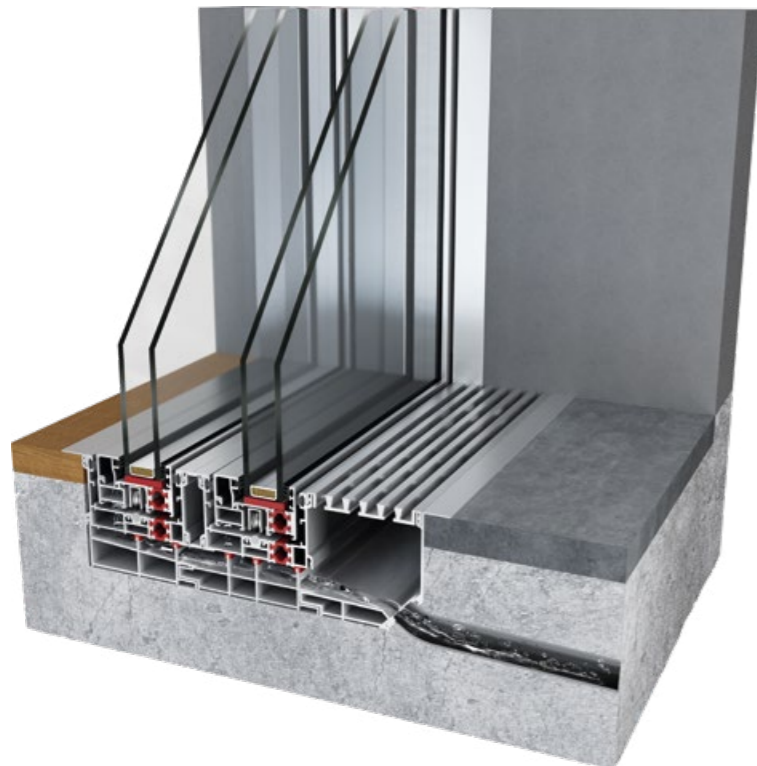

### SPACE INVISIBLE

Ο θαμμένος οδηγός, ορατός μόνο σαν δύο γραμμές δίνει τη δυνατότητα της συνέχειας του δαπέδου απο μέσα προς τα έξω.

The buried guide, only visible as two lines, provides the possibility of floor extension from the inside out.

Σελ. / Pg. 36-57

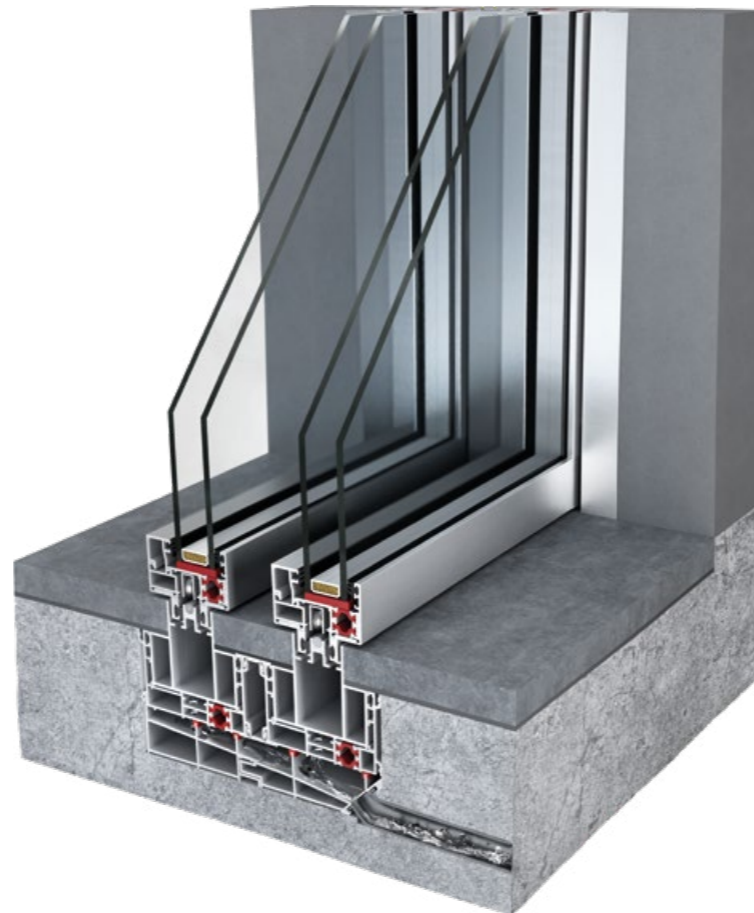

### SPACE REPLACE

Το ύψος της κάσας στα 33mm, το καθιστά ιδανική λύση για αντικατάσταση παλιών κουφωμάτων και συμμετοχή στο πρόγραμμα ΕΞΟΙΚΟΝΟΜΩ, χωρίς επιπλέον εργασίες και σκαψίματα. Το ορατό προφίλ αλουμινίου του φύλλου είναι 22mm.

The height of frame of 33mm makes it an ideal solution for the replacement of old frames without extra works and digging. The visible aluminium profile of the sash is 22mm.

Σελ. / Pg. 58-79

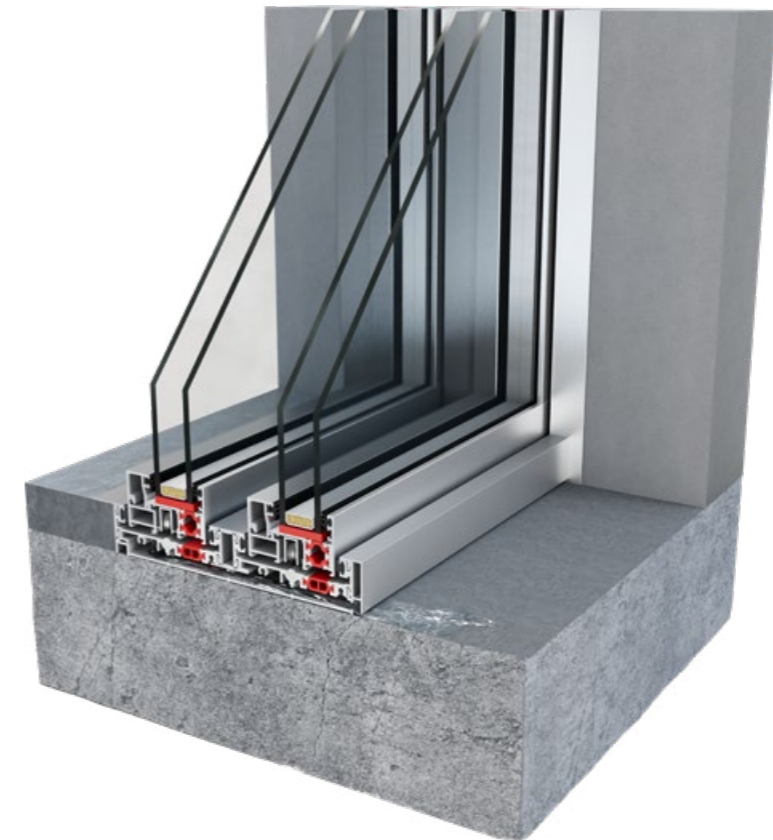



## ΤΕΧΝΙΚΑ ΧΑΡΑΚΤΗΡΙΣΤΙΚΑ

Πάχος υάλωσης φύλλου τζαμιού	<b>28-44mm</b>
Χειροκίνητο βάρος φύλλου	max <b>400Kg</b>
Ηλεκτροκίνητο βάρος φύλλου	<b>400Kg+</b>
Συντελεστής θερμοπερατότητας για διάσταση κουφώματος διαστάσεων 3,60x2,80m και υαλοπίνακα με $U_g = 1,0W/m^2K$	<b><math>U_w = 1,38W/m^2 K</math></b>
Υδατοστεγανότητα σύμφωνα με	<b>EN 12208:1999-11 / Class: E750</b>
Αεροδιαπερατότητα σύμφωνα με	<b>EN 12207:2016-12 / Class: 4</b>
Αντοχή σε ανεμοπίεση σύμφωνα με	<b>EN 12210:2016-03 / Class: C4/B4</b>
Ηχομείωση σύμφωνα με	<b>EN ISO 10140-2: 2021-05, EN ISO 717-1: 2020-12 / <math>R_w=43dB</math></b>

## TECHNICAL INFO

Glazing thickness	<b>28-44mm</b>
Manual sheet weight	max <b>400Kg</b>
Electric motor sheet weight	<b>400Kg+</b>
Thermal transmittance coefficient for frame dimensions of 3.60x2.80m and glazing with $U_g = 1,0W/m^2K$	<b><math>U_w = 1,38W/m^2 K</math></b>
Waterproofing in accordance with	<b>EN 12208:1999-11 / Class: E750</b>
Air permeability in accordance with	<b>EN 12207:2016-12 / Class: 4</b>
Resistance to wind load in accordance with	<b>EN 12210:2016-03 / Class: C4/B4</b>
Sound reduction in accordance with	<b>EN ISO 10140-2: 2021-05, EN ISO 717-1: 2020-12 / <math>R_w=43dB</math></b>

# OUR AWARDS

TA BPABEIA MAΣ





visit us online  
επισκεφθείτε μας

5<sup>ο</sup> χλμ Παλαιάς Εθνικής Οδού Λαρίσης - Αθηνών  
TK 415 00, Λάρισα - ΕΛΛΑΔΑ

2410 688 688  
info@exalco.gr

5<sup>th</sup> Km Old Nat. Rd Larissa - Athens  
PC 415 00, Larissa - GREECE

+30 2410 688 688  
info@exalco.gr



[exalco.gr](http://exalco.gr)